



Industrial Cellular Wi-Fi VPN Router Sparrow NW20 User Manual



REVISION HISTORY

Revision	Date	Firmware version	Revision Details
0	March 2021	1.0.0 (40ebe90)	Initial release.

Technical Support

E-mail: elmark@elmark.com.pl

Web: www.elmark.com.pl

Phone: 22 5418460

Interference Issues

Avoid possible radio frequency (RF) interference by following these guidelines:

- The use of cellular telephones or devices in aircraft is illegal. Use in aircraft may endanger operation and disrupt the cellular network. Failure to observe this restriction may result in suspension or denial of cellular services to the offender, legal action, or both.
- Do not operate in the vicinity of gasoline or diesel fuel pumps unless use has been approved or authorized.
- Do not operate in locations where medical equipment that the device could interfere with may be in use.
- Do not operate in fuel depots, chemical plants, or blasting areas unless use has been approved and authorized.
- Use care if operating in the vicinity of protected personal medical devices, i.e., hearing aids and pacemakers.
- Operation in the presence of other electronic equipment may cause interference if equipment is incorrectly protected. Follow recommendations for installation from equipment manufacturers.

Declaration of Conformity

SPARROW NW20 Series products are in conformity with the essential requirements and other relevant provisions of the CE and RoHS.



Table of Contents

Chapter 1.	Product Overview	5
1.1	Overview	5
1.2	Features and Benefits	5
1.3	General Specifications	6
1.4	Mechanical Specifications	8
1.5	Package Checklist.....	8
1.6	Order Information	10
Chapter 2.	Installation	11
2.1	LED Indicators.....	11
2.2	Ethernet Port Indicator.....	12
2.3	PIN Definition of Terminal block	12
2.4	Reset Button.....	13
2.5	Insert SIM card.....	13
2.6	Install Antenna	13
2.7	DIN-rail Mounting.....	15
2.8	Power Supply Installation	16
2.9	Power On The Router	16
Chapter 3.	Access to Web page.....	17
3.1	PC Configuration	17
3.2	Factory Default Settings	18
3.3	Login to Web Page.....	19
Chapter 4.	Web Configuration.....	20
4.1	Web Interface.....	20
4.2	Overview	22
4.2.1	Status	22
4.2.2	Syslog.....	24
4.3	Link Management.....	25
4.3.1	Connection Manager	25
4.3.2	Cellular	28
4.3.3	Ethernet.....	31
4.3.4	Wi-Fi.....	37
4.4	Industrial Interface	42
4.4.1	Serial.....	42
4.5	Network.....	46
4.5.1	Firewall.....	46
4.5.2	Route	49
4.5.3	VRRP.....	51
4.5.4	IP Passthrough.....	52
4.6	Applications.....	53
4.6.1	DDNS.....	53
4.6.2	SMS	55
4.6.3	Schedule Reboot	59
4.6.4	Call	60

4.7	VPN.....	61
4.7.1	OpenVPN	61
4.7.2	IPSec	67
4.7.3	GRE.....	70
4.8	Maintenance	72
4.8.1	Upgrade	72
4.8.2	Software.....	72
4.8.3	System	73
4.8.4	Configuration	77
4.8.5	Debug Tools.....	78
Appendix A -Glossary		80
Appendix B -Q&A		81
	No Signal	81
	Cannot detect SIM card	81
	Poor Signal	81
	IPSec VPN established, but LAN to LAN cannot communicate.....	82
	Forget Router Password	82
Appendix C - CLI.....		83

Chapter 1. Product Overview

1.1 Overview

Sparrow NW20 series industrial cellular VPN router offers a single, flexible platform to address a variety of wireless communications needs with over-the-air configuration and system monitoring for optimal connectivity. This router enables wireless data connectivity over public and private LTE cellular networks at 4G speeds.

NW20 series router has dual SIM backup, 2 LAN ports, 1 port could be changed to Ethernet WAN connection (for fixed internet fail over to cellular). An optional 802.11 b/g/n Wi-Fi interface access point and client operations supports connectivity to IP applications in a variety of different connection scenarios. RS232 and RS485 interfaces are provided to support Serial to IP communication.

NW20 series router supports 9 to 36 VDC wide range power inputs, designed with reverse-voltage protection mechanism for greater reliability. It is an advanced choice for universal wireless M2M applications with reliable features for data transmission.

1.2 Features and Benefits

Industrial internet access

- Wireless Mobile Broadband 2G / 3G / 4G Connection
- Remote access to SCADA System for Industrial Automation
- Reduce high costs for on-site maintenance

Designed for industrial usage

- Power Input Range 9 to 36 VDC
- Industrial designed for harsh environment
- Compact metal casing for easy mounting

Secure and reliable remote connection

- Connection manager ensure seamless communication
- Support Multiple VPN tunnels for data encryption
- Firewall prevents unsafe and unauthorized access

Easy to use and easy maintenance

- User-friendly web interface for human interaction
- Easy configuration for deployment
- Support remote management cloud

1.3 General Specifications

Cellular Interface

- Standards: FDD-LTE/TDD-LTE, WCDMA/UMTS/HSPA/HSPA+/EDGE/GPRS,
- 2× SMA female antenna connector
- 2 x SIM (3.0V & 1.8V)

Wi-Fi Interface (Optional)

- Standards: 802.11b/g/n, 150Mbps
- 1 x RP-SMA male antenna connector
- Support Wi-Fi AP and Client modes
- Security: WEP, WPA and WPA2 encryption
- Encryption: TKIP, CCMP

Ethernet Interface

- Standard: IEEE 802.3, IEEE 802.3u
- Number of Ports: 2 x 10/100 Mbps, RJ45 connector
- 1 x WAN interface (configurable on Web GUI)
- 1.5KV magnetic isolation protection

Serial Interface

- 1×RS232 (3 PIN): TX, RX, GND
- 1 x RS485 (2 PIN): Data+(A), Data-(B)
- Baud rate: 300 bps to 115200 bps
- Connector: terminal block
- 15KV ESD protection

Other Interfaces

- 1× RST button
- LED instruction: 1 x SYS, 1 x NET, 1 x USR, 3 x RSSI

Software

- Network protocols: DHCP, ICMP, PPPoE, HTTP, HTTPS, DNS, VRRP, NTP...
- VPN: IPSec, GRE, OpenVPN, DMVPN
- Policy: RIPv1/RIPv2/OSPF/BGP dynamic route (optional)
- Firewall & Filter: Port forwarding, DMZ, anti-DoS, ACL
- Serial port: TCP server and client, UDP
- Management: Web, Device Management Platform

Power Supply and Consumption

- Connector: 2-pin 3.5 mm female socket with lock
- Input voltage range: 9~36VDC
- Power consumption:

Idle: 100 mA@12V

Data link: 400 mA (peak) @12V

Physical Specification

- Ingress Protection: IP30
- Housing & Weight: Aluminum, 220g
- Dimension: 103.3mm x 82.8mm x 28.8mm (excluding antenna)
- Installations: Din-rail mounting

Environmental

- Operation temperature: -40~+75°C
- Store temperature: -40~+85°C
- Operation humidity: 5% to 95% non-condensing

1.4 Mechanical Specifications

Dimension: 103.3mm x 82.8mm x 28.8mm (excluding antenna)

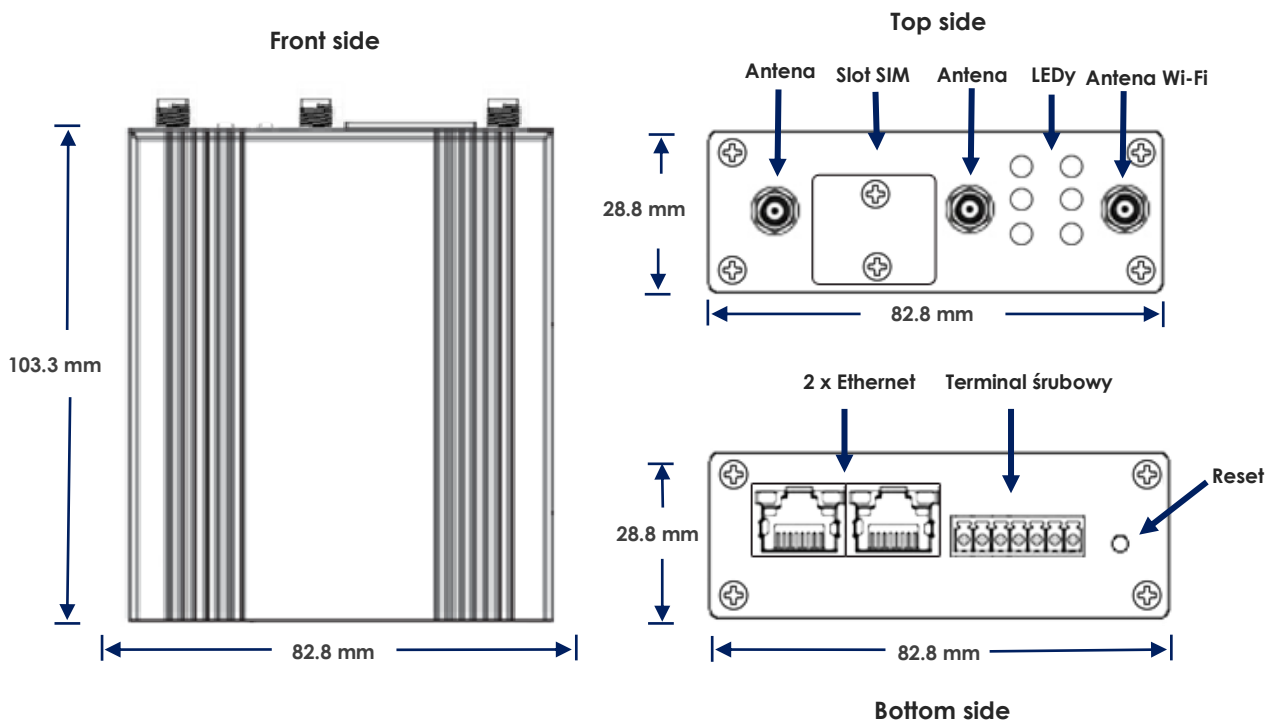

1.5 Package Checklist

NW20 series Router includes the parts shown in below, please verify your components.

NOTE: if any of the below items is missing or damaged, please contact your sales representative.

Included equipment

- 1 x Sparrow NW20 series Industrial Cellular VPN router (Wi-Fi optional)

NW20

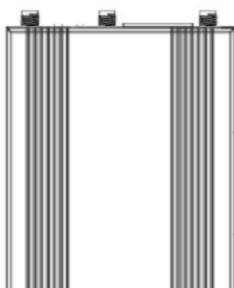

- 1 x 7-pin 3.5 mm male terminal block with lock for power input/RS232/RS485

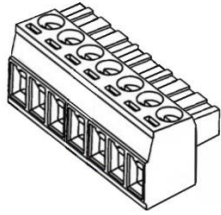

- 1 x Ethernet cable



- 1 x Quick Start Guide



Optional Accessories (sold separately)

- 3G/4G cellular antenna

Stubby antenna



Magnet antenna

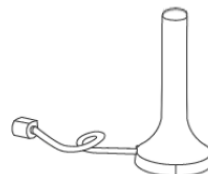

- RP-SMA Wi-Fi antenna

Stubby antenna

Magnet antenna



- 35mm Din-rail mounting kit

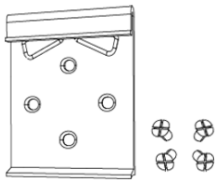

- AC/DC power adapter (12VDC, 1.5A; EU/US/UK/AU plug optional)

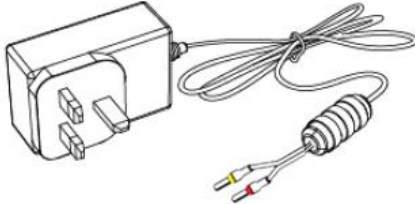

1.6 Order Information

Model	Part Number	Description
NW20	A312430	4G LTE, Dual SIMs, 2 x Eth, 1 x RS232 (3 PIN), 1 x RS485, 9 - 36VDC, 2.4GHz Wi-Fi

Chapter 2. Installation

2.1 LED Indicators

Name	Color	Status	Description
SYS	Green	Slow Blinking (500ms duration)	Operating normally
		Fast Blinking	System initialing
		Off	Power is off
NET	Green	On	Register to Highest priority network service (depend on Radio, e.g. Radio support LTE as Highest priority network).
		Fast Blinking (500ms duration)	Register to Non-Highest priority network service (depend on Radio, e.g. Radio support LTE as Highest priority network, then WCDMA and GPRS is non-highest priority network).
		Off	Register failed
USR: SIM	Green	On	Router is trying cellular connection with SIM1
		Fast Blinking (250ms duration)	Router is trying cellular connection with SIM2
		Off	No SIM detected
USR: Wi-Fi	Green	On	Wi-Fi is enable but without data transmission
		Blinking	Wi-Fi is enabled and data transmission
		Off	Wi-Fi is disable or initialize failed
Signal Strength Indicator 	Green	On, 3 LED light up	Signal strength (21-31) is high
		On, 2 LED light up	Signal strength (11-20) is medium
		On, 1 LED light up	Signal strength (1-10) is low
		Off	No signal

2.2 Ethernet Port Indicator

Name	Status	Description
Link indicator	On	Connection is established
	Blinking	Data is being transmitted
	Off	Connection is not established

NOTE: There are two LED indicators for each Ethernet port. Due to the chipset design NW20 router would only light up the green one(Link indicator) on left side, the right LED is Off without meaning.

2.3 PIN Definition of Terminal block

- Power Input & Serial Port

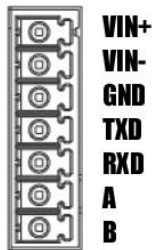

PIN	RS232	RS485	Power Input	Direction
1	--	--	VIN+	Positive (Red Line)
2	--	--	VIN-	Negative (Yellow Line)
3	GND	--	--	--
4	TXD	--	--	Router-->Device
5	RXD	--	--	Router<--Device
6	--	A	--	Router<-->Device
7	--	B	--	Router<-->Device

2.4 Reset Button

Function	Action
Reboot	Press the RST button within 3s under operation status
Factory Reset	Press the RST button between 3s to 10s, all LEDs blink few times then reboot the router manually.
Run Normally	Press the RST button more than 10s, router will run normally without reboot or factory reset.

2.5 Insert SIM card

- **Insert / Remove SIM card**

1. Make sure the power is disconnected.
2. Use a Phillips-head screwdriver to remove SIM slot cover.
3. Insert the SIM card(s) into the SIM sockets.
4. Replace the SIM slot cover.

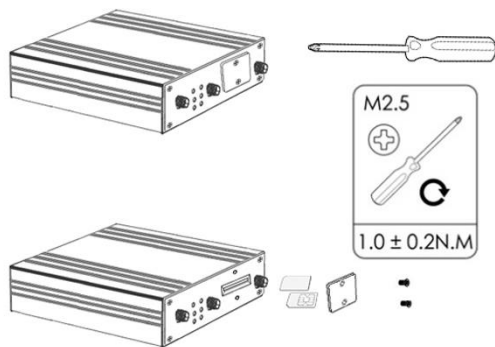

2.6 Install Antenna

- **Connect the cellular antenna to the MAIN and AUX connector on the unit.**



NOTE: NW20 router supports dual antennas with MAIN and AUX connectors. MAIN connector is for data receiving and transmission. AUX connector is for enhancing signal strength, which cannot be used separately.

- **Connect the Wi-Fi antenna to the Wi-Fi connector on the unit.**

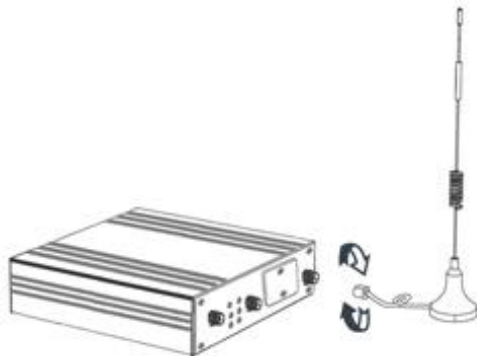

2.7 DIN-rail Mounting

1. Use 4 pcs of M3x6 flat head phillips screws to fix the DIN-rail to the router.
2. Insert the upper lip of the DIN-rail into the DIN-rail mounting kit.
3. Press the router towards the DIN-rail until it snaps into place.

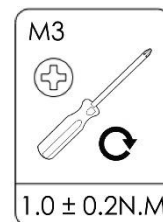
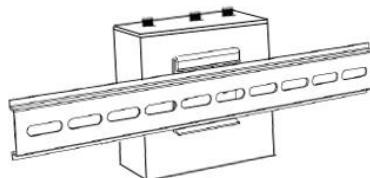
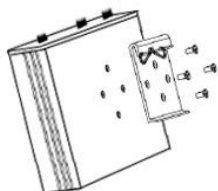

2.8 Power Supply Installation

1. Remove the pluggable connector from the unit, then loosen the screws for the locking flanges as needed.
2. Connect the wires of the power supply to the terminals.

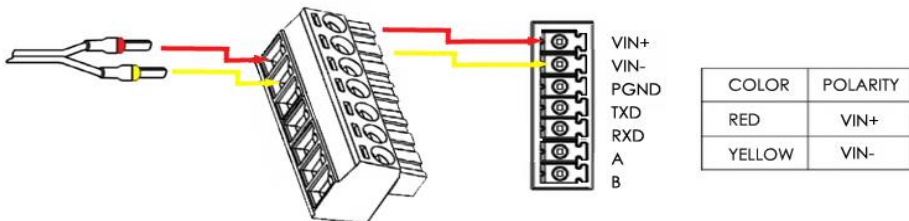

2.9 Power On The Router

1. Connect one end of the Ethernet cable to the LAN port on the unit and the other end to a LAN port on a PC.
2. Connect the AC power to a power source.
3. Router is ready when SYS LED is blinking.

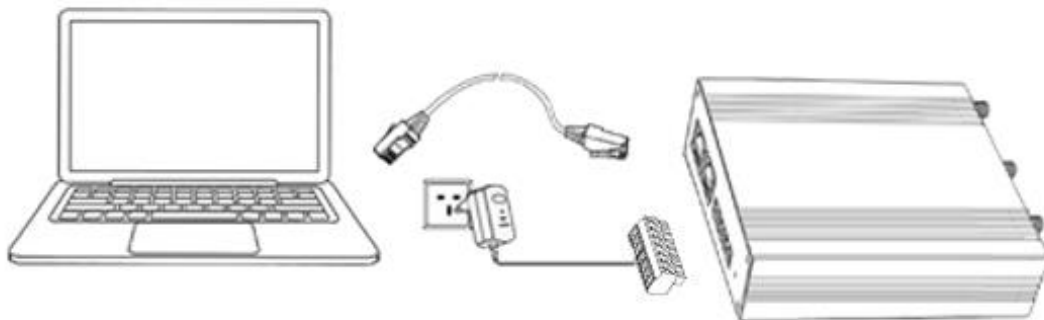

Chapter 3. Access to Web page

3.1 PC Configuration

NW20 router contains a DHCP server which will automatically assign an IP address to your PC, however in some cases the user may need to change the network settings on their PC to accept the IP address from the NW20. or you can configure a static IP address manually.

- **Obtain an IP address automatically**

The process required to do this differs depending on the version of Windows you are using.

NOTE: The following steps are based on Windows 7.

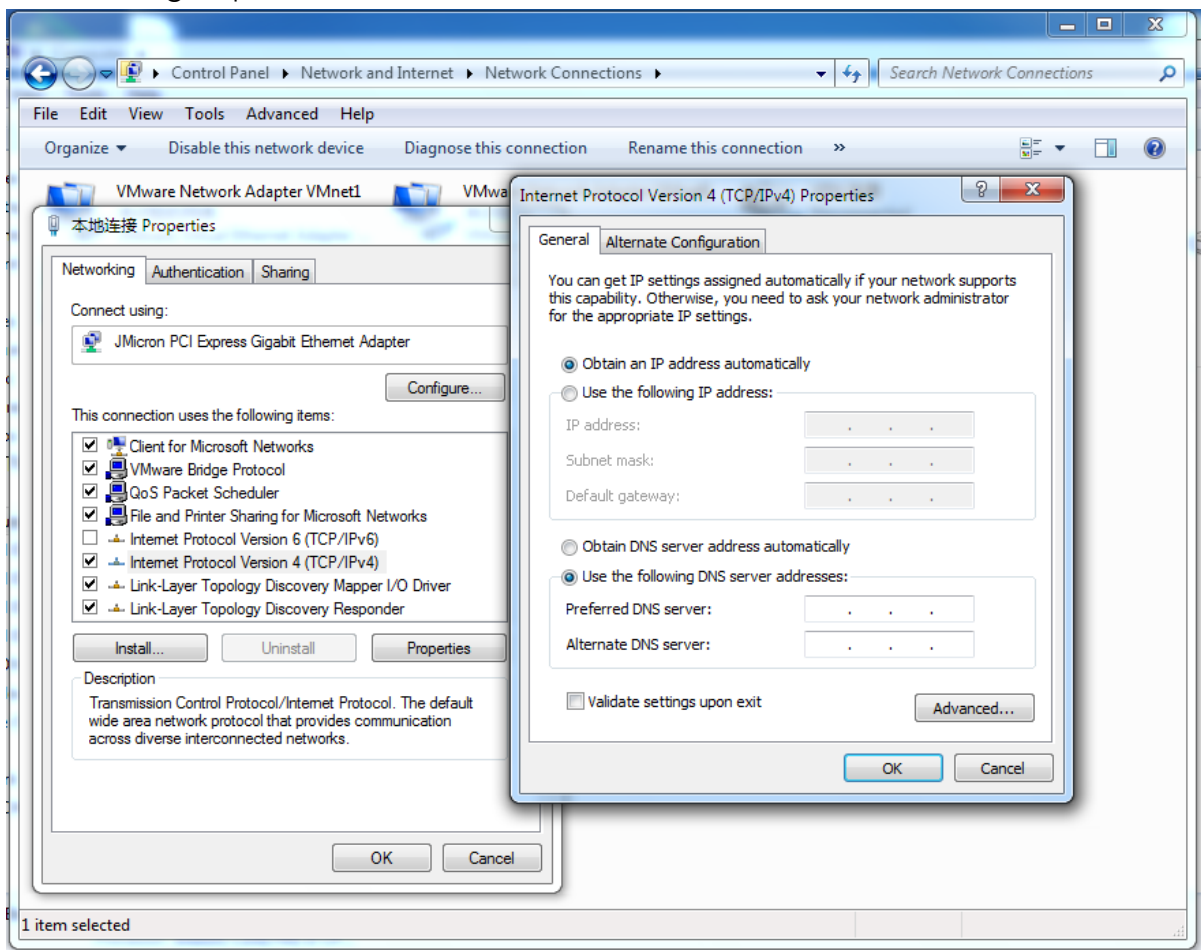

select **Start » Control Panel » Network Connections**. Right click **Local Area Connection** and select **Properties** to open the configuration dialog box for Local Area Connection. Select **Internet Protocol (TCP/IP)** and click **Properties** to open the TCP/IP configuration window. On the General tab, select **Obtain an IP address automatically** and **Obtain DNS server address automatically**. Click **OK** to complete TCP/IP configuration.

- **Set to a static IP address**

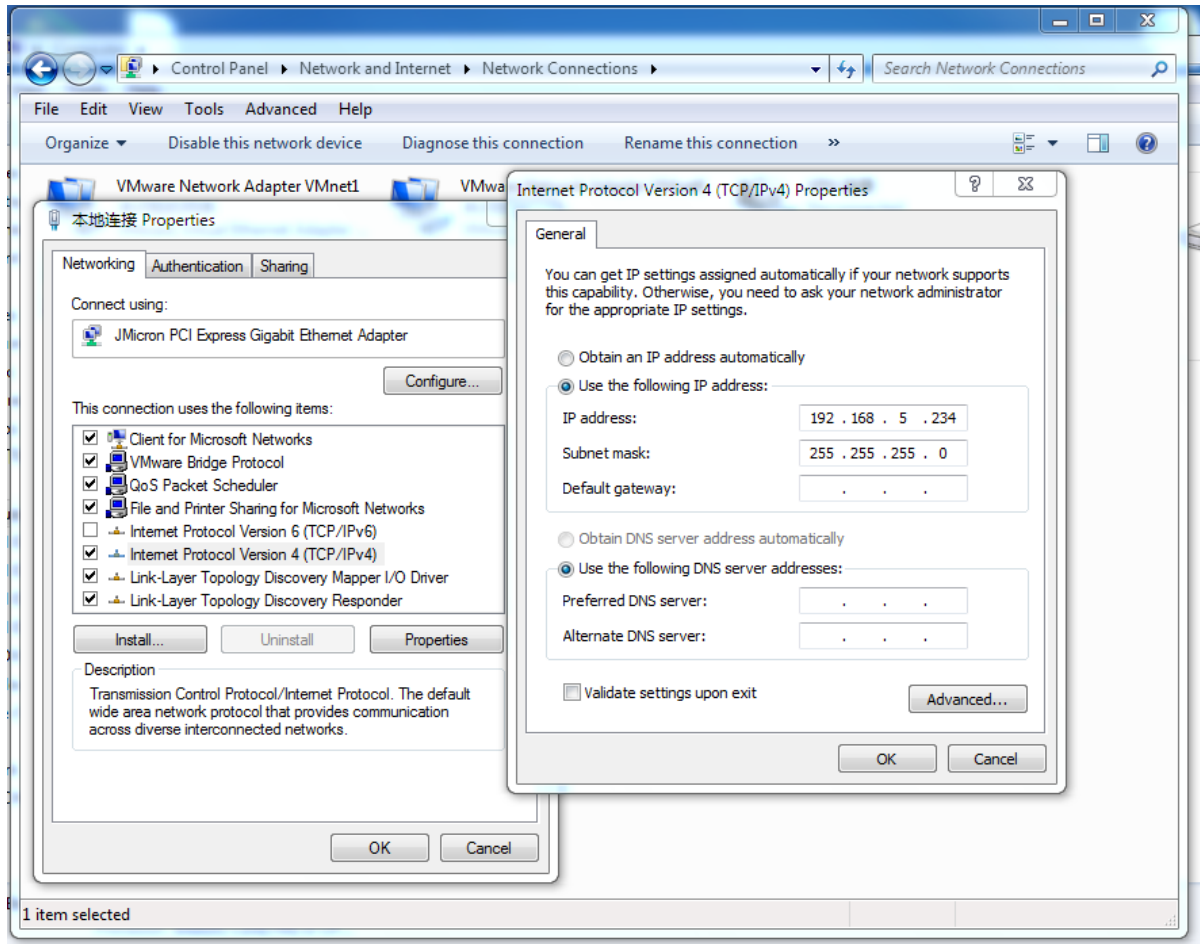

click "**Use the following IP address**" to assign a static IP manually within the same subnet of the router.

NOTE: *Default gateway* and *DNS server* is not necessary if PC not routing all traffic go through NW20 router.

3.2 Factory Default Settings

NW20 router supports Web-based configuration interface for management. If this is the first time for you to configure the router, please refer to below default settings.

Username: **admin**

Password: **admin**

LAN IP Address: **192.168.5.1** (Eth0~Eth1 bridge as LAN mode)

DHCP Server: **Enabled**

3.3 Login to Web Page

1. Start a Web browser on your PC (Chrome and IE are recommended), enter 192.168.5.1 into the address bar of the web browser.
2. Then use the default username and password(admin/admin), to log in to the router.

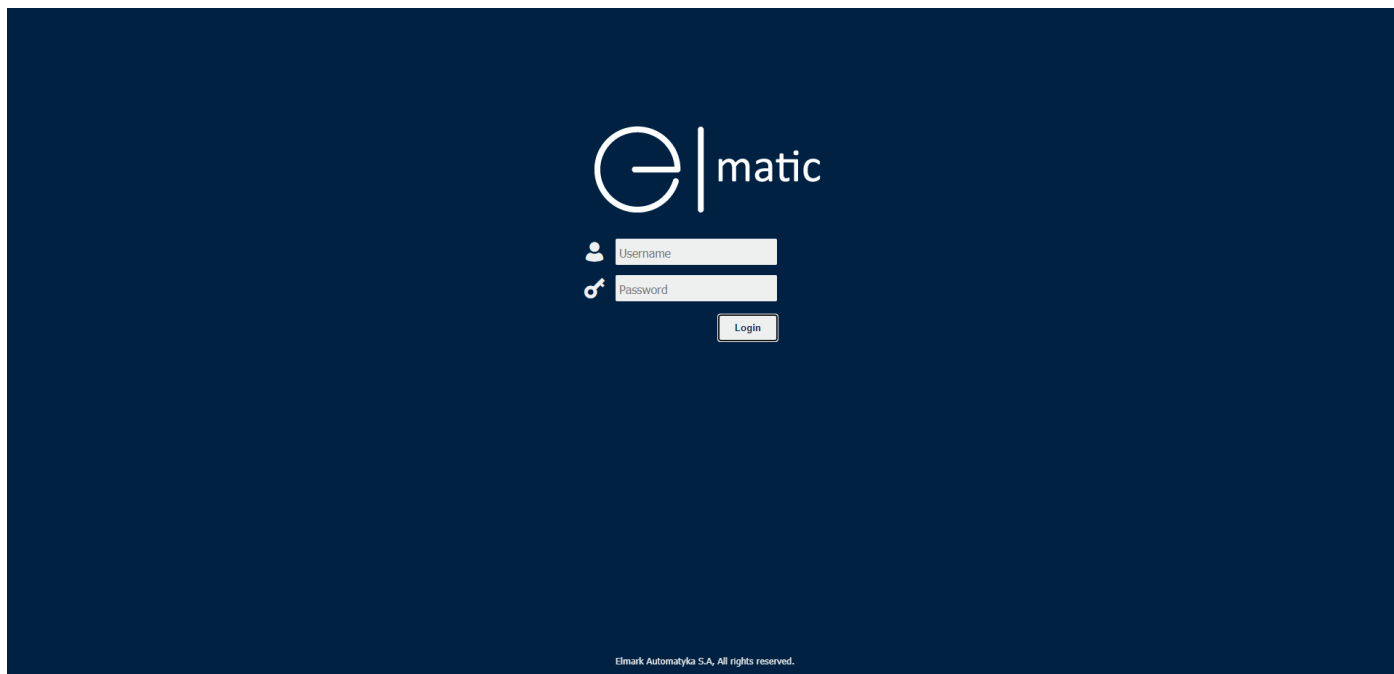

Chapter 4. Web Configuration

4.1 Web Interface

The NW20 router Web interface is divided into two sections. In the left pane is the main navigation menu. On the right is the content area for each page.



NOTE: The navigation menu may contain fewer sections than shown here depending on which options are installed in your unit.

- **Reboot:** reset the router within power disconnect.
- **Logout:** logout to web authorization page.



- **Save:** save the configuration on current page.
- **Apply:** apply the changes on current page immediately.



- **Close:** exit without changing the configuration on current page.

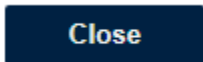

4.2 Overview

4.2.1 Status

You can view the system information of the router on this page.

<u>Status</u>		
System Information		
Device Model	Sparrow NW20	
System Uptime	00:04:21	
System Time	2021-07-14 13:31:48 ↻	
RAM Usage	23M Free/19M Shared/64M Total	
Firmware Version	1.0.0 (ee23d9b)	
Kernel Version	4.4.92	
Serial Number	21063124300013	

System Information

- **Device Module**
Displays the model name of router
- **System Uptime**
Displays the duration the system has been up in hours, minutes and seconds.
- **System Time**
Displays the current date and time.
- **RAM Usage**
Displays the RAM capacity and the available RAM memory.
- **Firmware Version**
Displays the current firmware version of router.
- **Kernel Version**
Displays the current kernel version of router.
- **Serial Number**
Display the serial number of router.

Active Link Information	
Link Type	WAN
IP Address	192.168.111.33
Netmask	255.255.255.0
Gateway	192.168.111.1
Primary DNS Server	192.168.129.1
Secondary DNS Server	192.168.111.1

Active Link Information

- **Link Type**
Current interface for internet access.
- **IP Address**
Displays the IP address assigned to this interface.
- **Netmask**
Displays the subnet mask of this interface.
- **Gateway**
Displays the gateway of this interface. This is used for routing packets to remote networks.
- **Primary DNS Server**
Displays the primary DNS server of this interface.
- **Secondary DNS Server**
Displays the secondary DNS server of this interface.

4.2.2 Syslog

Syslog	Events
Syslog Information	
<pre> Jul 14 13:27:51 router syslog.info syslogd started: BusyBox v1.25.1 Jul 14 13:27:56 router user.warn modem[1672]: can not get runing sim, use SIM1 as default Jul 14 13:27:56 router user.debug modem[1672]: modem power-on successfully Jul 14 13:27:57 router user.debug connection_manager[1693]: setup SIM 1 as initial SIM Jul 14 13:27:57 router user.debug connection_manager[1693]: wwan1 start connect Jul 14 13:27:57 router user.debug connection_manager[1693]: waiting for modem to initialize using SIM 1 Jul 14 13:27:57 router daemon.info dnsmasq[1715]: started, version 2.78 cachesize 150 Jul 14 13:27:57 router daemon.info dnsmasq[1715]: compile time options: no-IPv6 GNU-getopt no-DBus no-i18n no-IDN DHCP no-DHCPv6 no-Lua TFTP no-conntrack no-ipset no-auth no-DNSSEC no-ID loop-detect inotify Jul 14 13:27:57 router daemon.info dnsmasq-dhcp[1715]: DHCP, IP range 192.168.5.2 -- 192.168.5.200, lease time 2h Jul 14 13:27:57 router daemon.info dnsmasq-dhcp[1715]: DHCP, sockets bound exclusively to interface lan0 Jul 14 13:27:57 router daemon.warn dnsmasq[1715]: no servers found in /etc/resolv.conf, will retry Jul 14 13:27:57 router daemon.info dnsmasq[1715]: read /etc/hosts - 2 addresses Jul 14 13:27:57 router user.debug modem[1672]: modem enable successfully Jul 14 13:27:58 router daemon.notice procd: /etc/rc.d/S13lan: Command failed: Not found Jul 14 13:27:59 router local0.debug webserver: webserver started Jul 14 13:28:04 router cron.info crond[1891]: crond (busybox 1.25.1) started, log level 8 Jul 14 13:28:05 router daemon.info procd: - init complete - Jul 14 13:28:06 router daemon.err modprobe: qmi_wwan is already loaded Jul 14 13:28:07 router user.debug modem[1672]: ATZ Jul 14 13:28:07 router user.debug modem[1672]: ATZ^M Jul 14 13:28:07 router user.debug modem[1672]: OK Jul 14 13:28:09 router user.debug modem[1672]: AT+CPIN? Jul 14 13:28:09 router user.debug modem[1672]: +CPIN: READY Jul 14 13:28:09 router user.debug modem[1672]: OK Jul 14 13:28:09 router user.debug modem[1672]: AT+CGREG=2 Jul 14 13:28:09 router user.debug modem[1672]: OK Jul 14 13:28:09 router user.debug modem[1672]: AT+CGDCONT=1,"IP" Jul 14 13:28:09 router user.debug modem[1672]: OK Jul 14 13:28:09 router user.debug modem[1672]: AT+QCFG="nwscanmode",0,1 Jul 14 13:28:09 router user.debug modem[1672]: OK Jul 14 13:28:09 router user.debug modem[1672]: AT+QCFG="band",FFFF,FFFFFFFF,1 Jul 14 13:28:09 router user.debug modem[1672]: OK Jul 14 13:28:10 router user.debug modem[1672]: AT+CSQ Jul 14 13:28:10 router user.debug modem[1672]: +CSQ: 99,99 Jul 14 13:28:10 router user.debug modem[1672]: OK Jul 14 13:28:10 router user.debug modem[1672]: AT+CGREG? Jul 14 13:28:10 router user.debug modem[1672]: +CGREG: 2,2 Jul 14 13:28:10 router user.debug modem[1672]: OK </pre>	
<div style="display: flex; justify-content: space-around;"> Download Diagnosis Download Syslog Clear Refresh </div>	

Syslog Information

- Download Diagnosis**
 Download the Diagnosis file for analysis.
- Download Syslog**
 Download the complete syslog since last reboot.
- Clear**
 Clear the current page syslog printing.
- Refresh**
 Reload the current page with latest syslog printing.

4.3 Link Management





This section shows you the setup of link management.

4.3.1 Connection Manager

Status		Connection			
Connection Information					
Index	Type	Status	IP Address	Netmask	Gateway
1	WWAN1	Disconnected			
2	WAN	Connected	192.168.111.31	255.255.255.0	192.168.111.1

Connection Manager->Status

- Type**
 Displays the connection interface
- Status**
 Displays the connection status of this interface.
- IP Address**
 Displays the IP Address of this interface.
- Netmask**
 Displays the subnet mask of this interface.
- Gateway**
 Displays the gateway of this interface. This is used for routing packets to remote networks.

Status		Connection		
General Settings				
Priority	Enable	Connection Type	Description	
1	true	WWAN1		 
2	true	WAN		 

Click  to add a new priority interface.

Click  to edit current interface settings.

Click  to delete current interface.

Connection Manager->Connection

- **Priority**
Displays the priority list of default routing selection.
- **Enable**
Displays the connection enable status.
- **Connection Type**
Displays the name of this interface.
- **Description**
Displays the description of this connection.

Connection Settings

General Settings

Priority	<input type="text" value="1"/>	
Enable	<input checked="" type="checkbox"/>	
Connection Type	<input style="border: 1px solid #ccc;" type="text" value="WWAN1"/>	?
Description	<input type="text"/>	
NAT Enable	<input checked="" type="checkbox"/>	

ICMP Detection Settings

Enable	<input checked="" type="checkbox"/>	
Primary Server	<input type="text" value="8.8.8.8"/>	
Secondary Server	<input type="text" value="114.114.114.114"/>	
Interval	<input type="text" value="300"/>	?
Retry Interval	<input type="text" value="5"/>	?
Timeout	<input type="text" value="3"/>	?
Retry Times	<input type="text" value="3"/>	?

Connection Settings

- **Priority**
Displays current index on priority list.
- **Connection Type**
Select the available interface as outbound link.
NOTE: specify SIM1 carrier link as WWAN1, SIM2 carrier link as WWAN2.
- **NAT Enable**
Check this box to enable NAT (Network Address Translation) on the current link.
- **ICMP Detection Settings->Enable**

Check this box to detect link connection status based on pings to a specified IP address.

- **Primary Server**
Enter the primary IP address that pings will be sent to, to detect the link state. Recommend entering the IP address of known external reachable server or network (e.g. 8.8.8.8).
- **Secondary Server**
Enter the secondary IP address that pings will be sent to, when the primary server is ping failed, router would try to ping the secondary server.
- **Interval**
The duration of each ICMP detection in seconds.
- **Retry Interval**
The interval in seconds between each ping if no packets have been received.
- **Timeout**
Enter timeout for received ping reply to determine the ICMP detection failure.
- **Retry Times**
Specify the retry times for ICMP detection.

4.3.2 Cellular

NW20 Router main function is connecting to Internet by cellular modem.

Status		Cellular							
Cellular Information									
Index	Modem	Registration	CSQ	Operator	Network Type	IMEI	IMSI	TX Bytes	RX Bytes
1	EC25	Registered	High(27,-59d...	CHN-UNICOM	LTE	862708040702834	460015196274508	55.96 KB	87.14 KB
	Index	1							
	Modem	EC25							
	Registration	Registered							
	CSQ	High(27,-59dBm)							
	Operator	CHN-UNICOM							
	Network Type	LTE							
	IMEI	862708040702834							
	PLMN ID	46001							
	Local Area Code	25DC							
	Cell ID	6B42515							
	IMSI	460015196274508							
	TX Bytes	55.96 KB							
	RX Bytes	87.14 KB							
	Modem Firmware	EC25AUXGAR08A03M1G							

Copyright © 2018 Guangzhou Navigatowx Technologies Co., Ltd. All rights reserved.

Cellular->Status

- Modem**
 Displays the module of the modem used by this WWAN interface.
- Registration**
 Displays the registration status of SIM card.
- CSQ**
 Displays the signal strength of the carrier network.
- Operator**
 Displays the wireless network provider.
- Network Type**
 Displays the RF technology currently active. Example: LTE, UMTS, or CDMA.
- IMEI**
 International Mobile Electronic Identifier. Depending on the carrier and technology used, this may be required for the carrier when activating the data contract. In some cases this will be blank.
- PLMN ID**

Displays the current PLMN ID, including MCC, MNC, LAC and Cell ID.

- **Local Area Code**
Displays the location area code of the SIM card.
- **Cell ID**
Displays the Cell ID of the SIM card location.
- **IMSI**
International Mobile Subscriber Identity, as read from the SIM. This is the user's network subscription.
- **TX Bytes**
Displays the total bytes transmitted since the time the unit was connected. NW20 router would record this data with same SIM card, reboot would not erase this data.
- **RX Bytes**
Displays the total bytes received since the time the unit was connected. NW20 router would record this data with same SIM card, reboot would not erase this data.
- **Modem Firmware**
Displays firmware version of the module used by the WWAN interface.

Status		Cellular	
Modem General Settings			
Index	SIM Card	Auto APN	
1	SIM1	true	<input checked="" type="checkbox"/>
2	SIM2	true	<input checked="" type="checkbox"/>

Cellular

- **SIM Card**
Displays the SIM card support on this unit.
- **Auto APN**
Displays the Enable status of auto APN function.

SIM Card Settings	
Modem General Settings	
Index	<input type="text" value="1"/>
SIM Card	<input type="text" value="SIM1"/>
Auto APN	<input checked="" type="checkbox"/>
Dial Number	<input type="text" value="*99#"/>
Authentication Type	<input type="text" value="Auto"/>
PIN Code	<input type="text"/> ⓘ
Monthly Data Limitation	<input type="text" value="0"/> ⓘ
Monthly Billing Day	<input type="text" value="1"/> ⓘ
Data Roaming	<input checked="" type="checkbox"/>
Override Primary DNS	<input type="text"/>
Override Secondary DNS	<input type="text"/>
Modem Network Settings	
Network Type	<input type="text" value="Auto"/>
Use All Bands	<input checked="" type="checkbox"/>
<input type="button" value="Save"/> <input type="button" value="Close"/>	

SIM Card Settings

- **SIM Card**
Displays the current SIM card settings.
- **Auto APN**
Check this box enable auto checking the Access Point Name provided by the carrier.
- **Dial Number**
Enter the dial number of the carrier.
- **Authentication Type**
Authentication method used by the carrier. Possible selections are Auto, PAP, CHAP.
- **PIN Code**
Enter a 4-8 characters PIN code to unlock the SIM.
- **Monthly Data Limitation**
Enter the data total amount for SIM card, SIM card switchover when data reach limitation.
- **Monthly Billing Day**
Enter the date of renew data amount every month.
- **Data Roaming**
Enable or disable the data roaming function on the router.
- **Override Primary DNS**
Enter the primary DNS server will override the automatically obtained DNS.
- **Override Secondary DNS**
Enter the secondary DNS server will override the automatically obtained DNS.
- **Network Type**
Select the mode of operation of the cell module (Auto, 4G Firstly, 4G Only, etc.).
- **Use All Bands**
Check this box to enable all bands selection or choose specified bands.

4.3.3 Ethernet

The same instructions apply to settings for all Ethernet interfaces.

Status	Port Assignment	WAN	LAN	VLAN
Ethernet Port Information				
Index	Name	Status		
1	ETH0	Down		
2	ETH1	Up		
Interface Information				
Index	Name	MAC Address		
1	wan	A8:3F:A1:E1:01:16		
2	lan0	A8:3F:A1:E0:D3:EE		
DHCP Lease Table				
Index	MAC Address	IP Address	Lease Expires	Hostname

Ethernet->Status

- **Ethernet Port Information**
Displays the port physical connected states.
- **Interface Information**
Displays the name and MAC address of Ethernet interface.
- **DHCP Lease Table**
Displays the current IP address assigned to DHCP client.

Ethernet->Port Assignment

- **Port**
Displays the port states and numbers of this unit.
- **Interface**
Displays the port states of belong subnet.

Port Settings

General Settings

Index

Port

Interface

Note: Please make sure LAN0 is assigned and existing.

Ethernet->Port Settings

- **Port**
Indicate the current configurate port.
- **Interface**
Select belong subnet for current configurate port.

Status	Port Assignment	<u>WAN</u>	LAN	VLAN
General Settings				
		Connection Type	<input type="text" value="DHCP"/>	
Advanced Settings				
		MTU	<input type="text" value="1500"/>	
		Override Primary DNS	<input type="text"/>	
		Override Secondary DNS	<input type="text"/>	
Secondary Wan Settings				
Index	IP Address	Netmask	+	

Ethernet->WAN

- **Connection Type**
If you select DHCP Client, external DHCP server will assign an IP address to this unit.
- **MTU**
Maximum Transmission Unit, maximum packet size allowed to be transmitted. Should be left as default value of 1500 in most cases.
- **Override Primary DNS**
Enter the primary DNS server will override the automatically obtained DNS.
- **Override Secondary DNS**
Enter the secondary DNS server will override the automatically obtained DNS.

Ethernet->WAN->Secondary Wan Settings

- **IP Address**
Enter the IP address of secondary wan interface.
- **Netmask**
Enter the netmask of secondary wan interface.



NW20 also support WAN connection type set to Static IP and PPPoE mode.

Status	Port Assignment	<u>WAN</u>	LAN	VLAN
General Settings				
		Connection Type	<input type="text" value="Static IP"/>	
		IP Address	<input type="text"/>	
		Netmask	<input type="text"/>	
		Gateway	<input type="text"/>	
		Primary DNS	<input type="text"/>	
		Secondary DNS	<input type="text"/>	

Status	Port Assignment	<u>WAN</u>	LAN	VLAN
General Settings				
	Connection Type	PPPoE ▾		
	Authentication Type	Auto ▾		
	Username	<input type="text"/>		
	Password	<input type="text"/>		

Ethernet->WAN->Static IP or PPPoE

- **IP Address**
Static address for this interface. It must be on the same subnet as the gateway.
- **Netmask**
Will be assigned by the gateway.
- **Gateway**
IP address of the Gateway (DHCP Host). If not known this can be left as all zeros.
- **Primary DNS**
IP address of the primary DNS server.
- **Secondary DNS**
IP address of the secondary DNS server.
- **Authentication Type**
Authentication method used by the carrier. Possible selections are Auto, PAP, CHAP.
- **Username**
Username to provide when connecting.
- **Password**
Password to provide when connecting.

Status	Port Assignment	WAN	<u>LAN</u>	VLAN
General Settings				
Index	Interface	IP Address	Netmask	
1	LAN0	192.168.5.1	255.255.255.0	 
Multiple IP Settings				
Index	Interface	IP Address	Netmask	
				

Ethernet->LAN

- **Interface**
Displays current name of LAN subnet.
- **IP Address**
Displays LAN IP address of this subnet.
- **Netmask**
Displays subnet mask for this subnet.

LAN Settings

General Settings

Index	<input type="text" value="1"/>
Interface	<input type="text" value="LAN0"/>
IP Address	<input type="text" value="192.168.5.1"/>
Netmask	<input type="text" value="255.255.255.0"/>
MTU	<input type="text" value="1500"/>

DHCP Settings

Enable	<input checked="" type="checkbox"/>
Mode	<input type="text" value="Server"/>
IP Pool Start	<input type="text" value="192.168.5.2"/>
IP Pool End	<input type="text" value="192.168.5.200"/>
Netmask	<input type="text" value="255.255.255.0"/>
Lease Time	<input type="text" value="120"/>
Gateway	<input type="text"/>
Primary DNS	<input type="text"/>
Secondary DNS	<input type="text"/>
WINS Server	<input type="text"/>

DHCP Settings

Enable	<input checked="" type="checkbox"/>
Mode	<input type="text" value="Relay"/>
Relay Server	<input type="text"/>

Ethernet->LAN

- **Interface**
Select the configure LAN port of this subnet.
- **IP Address**
Enter LAN IP address for this interface.
- **Netmask**
Enter subnet mask for this subnet.
- **MTU**
Maximum Transmission Unit, maximum packet size allowed to be transmitted. Should be left as default value of 1500 in most cases.
- **Enable**
Check this box to enable DHCP feature on current LAN port.
- **Mode**
Select the DHCP working mode from "Server" or "Relay".

- **Relay Server**
Enter the IP address of DHCP relay server.
- **IP Pool Start**
External LAN devices connected to this unit will be assigned IP address in this range when DHCP is enabled. This is the beginning of the pool of IP addresses.
- **IP Pool End**
This is the end of the pool of IP addresses.
- **Netmask**
Subnet mask of the IP address obtained by DHCP clients from DHCP server.
- **Lease Time**
The lease time of the IP address obtained by DHCP clients from DHCP server.
- **Gateway**
The gateway address obtained by DHCP clients from DHCP server.
- **Primary DNS**
Primary DNS server address obtained by DHCP clients from DHCP server.
- **Secondary DNS**
Secondary DNS server address obtained by DHCP clients from DHCP server.
- **WINS Server**
Windows Internet Naming Service obtained by DHCP clients from DHCP server.

MAC Binding IP Settings	
Index	<input type="text" value="1"/>
Enable	<input checked="" type="checkbox"/>
Description	<input type="text"/>
Host MAC Address	<input type="text"/> ?
Host IP Address	<input type="text"/>

Save Close

Ethernet->LAN->MAC Binding IP Settings

- **Enable**
Check this box to enable MAC binding IP feature.
- **Description**
Enter the description for MAC binding IP feature.
- **Host MAC Address**
Enter the host MAC address.
- **Host IP Address**
Enter the host IP address.

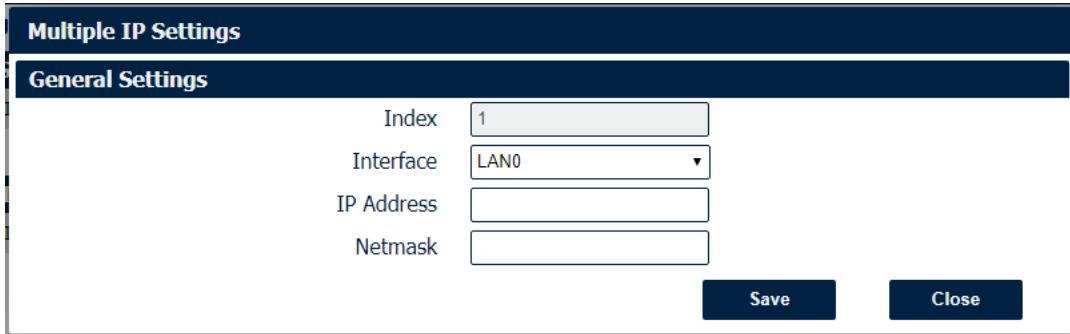

The screenshot shows a dialog box titled "Multiple IP Settings" with a sub-section "General Settings". It contains four input fields: "Index" with the value "1", "Interface" with a dropdown menu showing "LAN0", "IP Address" (empty), and "Netmask" (empty). At the bottom right, there are two buttons: "Save" and "Close".

Ethernet->LAN->Multiple IP Settings

- **Interface**
Select the configurate LAN port of this subnet.
- **IP Address**
Enter multiple IP address for this interface.
- **Netmask**
Enter subnet mask for this subnet.

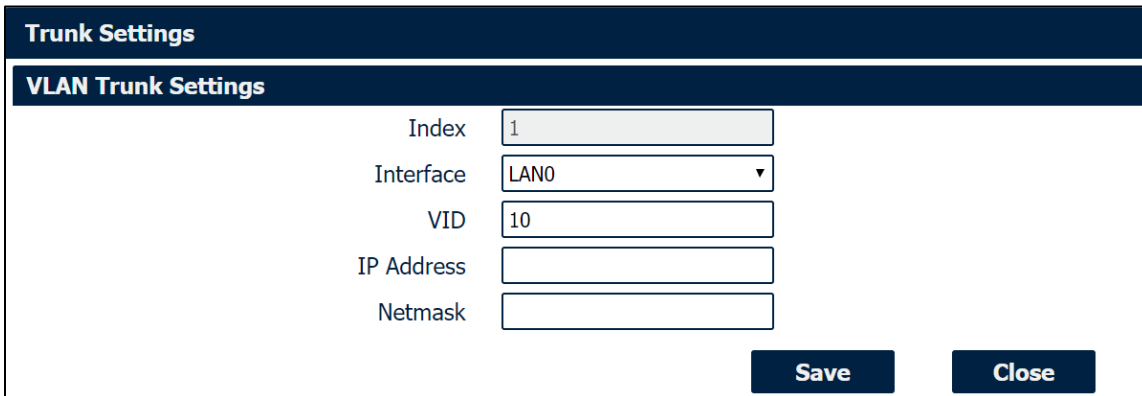

The screenshot shows a dialog box titled "Trunk Settings" with a sub-section "VLAN Trunk Settings". It contains five input fields: "Index" with the value "1", "Interface" with a dropdown menu showing "LAN0", "VID" with the value "10", "IP Address" (empty), and "Netmask" (empty). At the bottom right, there are two buttons: "Save" and "Close".

Ethernet->VLAN->VLAN Trunk Settings

- **Interface**
Select the LAN port for VLAN trunk.
- **VID**
Specify the VLAN ID for VLAN trunk.
- **IP Address**
Enter IP address for this VLAN trunk.
- **Netmask**
Enter subnet mask for this VLAN trunk.

4.3.4 Wi-Fi

NW20 router could only be set to function as either a Wi-Fi Client or a Wi-Fi Access Point, but not both simultaneously. Select Wi-Fi (Access Point) from the main navigation menu to Wi-Fi (default as Access Point) page, which contains tabs for configuration of the Wi-Fi Access Point interface.

You could review the Wi-Fi connection status as below.

Status	Basic	WiFi AP	
WiFi Status			
Status	Ready		
SSID	wifi-sparrow		
MAC Address	a8:3f:a1:e0:da:a5		
Current Channel	1		
Channel Width	40 MHz		
TX Power	20.00 dBm		
Associated Station			
Index	MAC Address	Signal	Station Name
1	ba:42:d0:7f:1e:6e	-33 dBm	Pixel-4a

Status	Basic	WiFi AP
Basic Settings		
Running Mode	<input type="text" value="AP"/>	
Country Code	<input type="text" value="CN"/>	

Wi-Fi->Basic

- **Running Mode**
Select the configurate Wi-Fi mode from AP or Client.
- **Country Code**
Enter the country where the AP is located.

Wi-Fi AP

Wi-Fi AP settings page as below.

Status	Basic	<u>WiFi AP</u>
WiFi AP Settings		
Enable	<input checked="" type="checkbox"/>	
SSID	<input type="text" value="wifi-a-p"/>	
Enable Broadcast SSID	<input type="checkbox"/>	
Security Mode	<input type="text" value="WPA PSK"/>	
WPA Type	<input type="text" value="Auto"/>	
Encryption Type	<input type="text" value="Auto"/>	
Password	<input type="text"/>	<input style="font-size: 0.8em; vertical-align: middle;" type="button" value="?"/>
Advanced Settings		
Channel	<input type="text" value="Auto"/>	
Wireless Mode	<input type="text" value="802.11bgn"/>	
Channel Width	<input type="text" value="40 MHz"/>	
Beacon TX Rate HT MCS Index	<input type="text" value="Auto"/>	<input style="font-size: 0.8em; vertical-align: middle;" type="button" value="?"/>
TX Power	<input type="text" value="High"/>	
Beacon Interval	<input type="text" value="100"/>	
DTIM Period	<input type="text" value="100"/>	
Max Client Support	<input type="text" value="64"/>	
Enable Short GI	<input checked="" type="checkbox"/>	
Enable AP Isolate	<input type="checkbox"/>	

Wi-Fi->Wi-Fi AP

- **Enable**
Check this box will enable the Wireless interface.
- **SSID**
The SSID is the name of the wireless local network. Devices connecting to the NW20 router WiFi access will identify the Access Point by this SSID.
- **Enable Broadcast SSID**
When the checkbox is not checked, SSID broadcast is disabled, other wireless devices can't not find the SSID, and users have to enter the SSID manually to access to the wireless network.
- **Security Mode**
Select security mode from "None", "WEP" or "WPA PSK".
- **WPA Type**
Select WPA Type from "Auto", "WPA" and "WPA2".
- **Encryption Type**
Select the encryption method. Options are "Auto", "TKIP", or "CCMP". Because these options depend on the authentication method selected, some options will not be available.
- **Password**
Enter the pre-shared key of WEP/WPA encryption.

- **Channel**
Select the Wi-Fi channel the module will transmit on. If there are other Wi-Fi devices in the area the NW20 router should be set to a different channel than the other access points. Channels available for selection depend on the selected Band.
- **Wireless Mode**
Select the Wi-Fi 802.11 mode: B, G, or N. Available selections depend on selected Band.
- **Channel Width**
Select the width of the Wi-Fi channel. 20 MHz will limit the channel to 20 MHz wide; 20/40 MHz will enable the use of a 40 MHz wide channel when available.
- **Beacon TX Rate HT MCS Index**
Modulation and Coding Scheme, The MCS modulation coding table is a representation proposed by 802.11n to characterize the communication rate of the WLAN. The MCS takes the factors affecting the communication rate as the columns of the table and uses the MCS index as a row to form a rate table.
- **TX power**
Select the transmission power for the AP from "High", "Medium" and "Low".
- **Beacon Interval**
Enter the interval of time in which the router AP broadcasts a beacon which is used for wireless network authentication.
- **DTIM Period**
Enter the delivery traffic indication message period and the router AP will multicast the data according to this period.
- **Max Client Support**
Enter the maximum number of clients to access when the router is configured as AP.
- **Enable Short GI**
Check this box to enable Short GI(guard interval), Short GI is a blank time between two symbols, providing a long buffer time for signal delay.
- **Enable AP Isolate**
Check this box to enable AP isolate, the route will isolate all connected wireless devices.

Wi-Fi Client

Wi-Fi Client settings page as below.

Status	Basic	<u>WiFi Client</u>
WiFi Client Settings		
Enable	<input checked="" type="checkbox"/>	
Connect to Hidden SSID	<input type="checkbox"/>	
SSID	<input type="text"/>	
Password	<input type="text"/>	
IP Address Settings		
Connection Type	<input type="text" value="DHCP"/>	

Status	Basic	<u>WiFi Client</u>
WiFi Client Settings		
Enable	<input checked="" type="checkbox"/>	
Connect to Hidden SSID	<input type="checkbox"/>	
SSID	<input type="text"/>	
Password	<input type="text"/>	
IP Address Settings		
Connection Type	<input type="text" value="Static IP"/>	
IP Address	<input type="text"/>	
Netmask	<input type="text"/>	
Gateway	<input type="text"/>	
Primary DNS	<input type="text"/>	
Secondary DNS	<input type="text"/>	

Wi-Fi->Wi-Fi Client

- **Enable**
Check this box will enable the Wireless interface.
- **Connect to Hidden SSID**
Check this box will enable connect to hidden SSID.
- **SSID**
The SSID of external access point.
- **Password**
Enter the password of external access point.
- **Connection Type**
Select from DHCP Client or Static IP address.
- **IP Address**
Static address for this interface. It must be on the same subnet as the gateway.
- **Netmask**
Will be assigned by the gateway.
- **Gateway**
IP address of the Gateway.
- **Primary DNS**
Enter the primary DNS server will override the automatically obtained DNS.
- **Secondary DNS**
Enter the secondary DNS server will override the automatically obtained DNS.

4.4 Industrial Interface

The Industrial page contains tabs for making configuration settings for Serial RS232 and RS485, Digital input and output. Select Serial & Digital IO from the main navigation menu to navigate to this page.

4.4.1 Serial

You could review the status of serial connection.

<u>Status</u>		Connection			
Serial Information					
Index	Enable	Serial Type	Transmission Method	Protocol	Connection Status
1	false	RS485	Transparent	TCP Client	Disconnected
2	false	RS232	Transparent	TCP Client	Disconnected

Serial->Status

- Enable**
 Displays status of current serial function.
- Serial Type**
 Displays the serial type of COM port.
- Transmission Method**
 Displays the transmission method of this serial port.
- Protocol**
 Displays the protocol used by this serial port.
- Connection Status**
 Displays the connection status of this serial port.

Status		Connection				
Serial Connection Settings						
Index	Enable	Port	Baud Rate	Data Bits	Stop Bits	Parity
1	false	COM1	115200	8	1	None
2	false	COM2	115200	8	1	None

Serial->Connection

- **Enable**
Displays status of current serial function.
- **Port**
Displays the serial type of COM port.
- **Baud Rate**
Displays the serial port baud rate.
- **Data Bits**
Displays the serial port Data Bits.
- **Stop Bits**
Displays the serial port Stop Bits.
- **Parity**
Displays the serial port parity.

Connection Settings

Serial Connection Settings

Index:

Enable:

Port:

Baud Rate:

Data Bits:

Stop Bits:

Parity:

Transmission Settings

Transmission Method:

MTU: ?

Protocol:

Remote Address:

Remote Port:

Sync to Secondary Address:

Remote Secondary Address:

Remote Secondary Port:

Serial->Connection Settings

- Baud Rate**
 Select the serial port baud rate. Supported values are 300, 600, 1200, 2400, 4800, 9600, 19200, 38400, 57600, or 115200.
- Data Bits**
 Select the values from 7 or 8.
- Stop Bits**
 Select the values from 1 or 2.
- Parity**
 Select values from none, even, odd, mark, space.
- Transmission Method**
 Select the transmission method for serial port. Optional for "Transparent", "Modbus RTU Gateway" and "Modbus ASCII Gateway".
- MTU**
 Maximum Transmission Unit, maximum packet size allowed to be transmitted. Should be left as default value of 1024 in most cases.
- Protocol**
 Select the mode for Serial IP communication. Supported modes are UDP, TCP Server, or TCP Client.
- Remote IP Address**
 Enter the IP address of the remote server.
- Remote Port**
 Enter the port number of the remote server.
- Sync to Secondary Address**
 Check this box to enable the data send to secondary remote server for data backup.
- Remote Secondary Address**
 Enter the remote backup server IP address.
- Remote Secondary Port**
 Enter the remote backup server port.

Below window displays different settings when you select **TCP Server** on Protocol.

Transmission Settings	
Transmission Method	Transparent ▼
MTU	1024 ⓘ
Protocol	TCP Server ▼
Local IP Address	<input type="text"/>
Local Port	2000

Serial->Connection Settings

- Local IP Address**
 Enter the IP Address of the local endpoint.
- Local Port**
 The port number assigned to the serial IP port on which communications will take place.

Below window displays different settings when you select **UDP** on Protocol.

Transmission Settings	
Transmission Method	Transparent ▼
MTU	1024 ⓘ
Protocol	UDP ▼
Local IP Address	<input type="text"/>
Local Port	2000
Remote IP Address	<input type="text"/>
Remote Port	2000

Serial->Connection Settings

- **Local IP Address**
Enter the IP Address of the local endpoint.
- **Local Port**
The port number assigned to the serial IP port on which communications will take place.
- **Remote IP Address**
Enter the IP address of the remote server.
- **Remote Port**
Enter the port number of the remote server.

4.5 Network

4.5.1 Firewall

Firewall rules are security rule-sets to implement control over users, applications or network objects in an organization. Using the firewall rule, you can create blanket or specialized traffic transit rules based on the requirement.

ACL	Port Mapping	DMZ	NAT	URL Filter				
General Settings								
Default Policy				Accept				
ACL Rule Settings								
Index	Description	Chain	Protocol	Source Address	Source Port	Destination Address	Destination Port	

Firewall->ACL

- Default Policy**

Select the "Accept" or "Drop" from the list, the packets which are not included in the access control list will be processed by the default filter policy.

An access control list (ACL), with respect to a computer file system, is a list of permissions attached to an object. An ACL specifies which users or system processes are granted access to objects, as well as what operations are allowed on given objects.

ACL Settings	
ACL Rule Settings	
Index	1
Description	
Chain	FORWARD
Protocol	All
Source Address	<input type="text"/> ?
Destination Address	<input type="text"/> ?
<input type="button" value="Save"/> <input type="button" value="Close"/>	

Firewall->ACL

- Description**
 Add a description for this rule.
- Chain**
 Specify the forward rule of ACL, choose from "FORWARD" and "INPUT".
- Protocol**
 All: Any protocol number.
 TCP: The TCP protocol.
 UDP: The UDP protocol.
 TCP & DUP: both TCP and UDP protocol
 ICMP: The ICMP protocol.
- Source Address**
 A specific host IP address can also be specified, or a range of IP addresses via a bitmask (the box following the /).
- Destination Address**
 A specific IP address can also be specified, or a range of IP addresses via a bitmask (the box following the /).

Port Mapping Settings

Port Mapping rule Settings

Index	<input style="width: 90%;" type="text" value="1"/>
Description	<input style="width: 90%;" type="text"/>
Protocol	<input style="width: 90%;" type="text" value="All"/> ?
Remote Address	<input style="width: 90%;" type="text"/> ?
Remote Port	<input style="width: 90%;" type="text"/> ?
Local Address	<input style="width: 90%;" type="text"/> ?
Local Port	<input style="width: 90%;" type="text"/> ?

Firewall->Port Mapping

- Description**
 Add a description for this rule.
- Protocol**
 All: Any protocol number.
 TCP: The TCP protocol.
 UDP: The UDP protocol.
- Remote Address**
 Enter a WAN IP address that is allowed to access the unit.
- Remote Port**
 Enter the external port number range for incoming requests.
- Local Address**

Sets the LAN address of a device connected to one of the Fusion's LAN interfaces. Inbound requests will be forwarded to this IP address.

- **Local Port**

Sets the LAN port number range used when forwarding to the destination IP address.

ACL	Port Mapping	DMZ	NAT	URL Filter
General Settings				
Enable <input type="checkbox"/>				
Remote Address <input type="text" value="0.0.0.0/0"/> ?				
DMZ Host Address <input type="text"/>				

Firewall->DMZ

- **Enable**
Check this box to enable DMZ function.
- **Remote Address**
Optionally restricts DMZ access to only the specified WAN IP address.
NOTE: If set to 0.0.0.0/0, the DMZ is open to all incoming WAN IP addresses.
- **DMZ Host Address**
The WAN IP address which has all ports exposed except ports defined in the Port Forwarding configuration.

1-1 NAT Settings	
1-1 NAT Settings	
Index	<input type="text" value="1"/>
Description	<input type="text"/>
Interface Address	<input type="text"/>
Host Address	<input type="text"/>
Interface To Host	<input type="text"/>
<input type="button" value="Save"/> <input type="button" value="Close"/>	

Firewall->NAT

- **Description**
Enter a description of 1-to-1 NAT setting.
- **Interface Address**
Specify the interface address that need to be accessed before NAT.
- **Host Address**
Specify the host address that need to be accessed after NAT.
- **Interface To Address**
Specify the interface that connected to host, like lan0, lan1, lan2, lan3.

URL Filter Settings

URL Filter Settings

Index

URL

Save
Close

Firewall->URL Filter

- **URL**
Enter the URL to block the data traffic to go to the website. For example, www.google.com

4.5.2 Route

Static Routing refers to a manual method of setting up routing between networks. Select the Static Routing tab to add static routes to the Static Route Table.

Please refer current route table as below.

Status	Static Route				
Route Table Information					
Index	Destination	Netmask	Gateway	Metric	Interface
1	192.168.5.0	255.255.255.0	0.0.0.0	0	lan0

Route->Route Table Information

- **Destination**
Displays the destination of routing traffic.
- **Netmask**
Displays the subnet mask of this routing.
- **Gateway**
Displays the gateway of this interface. This is used for routing packets to remote networks.
- **Metric**
Displays the metric value of this interface.
- **Interface**
Displays the outbound interface of this route.

Static Route Settings

Static Route Settings

Index	<input type="text" value="1"/>	
Description	<input type="text"/>	
IP Address	<input type="text"/>	
Netmask	<input type="text"/>	
Gateway	<input type="text"/>	
Metric	<input type="text" value="0"/>	?
Interface	<input type="text"/>	?

Route->Static Route Settings

- **Description**
Enter the description of current static route rule.
- **IP Address**
Enter the IP address of the destination network.
- **Netmask**
Enter the subnet mask of the destination network.
- **Gateway**
Enter the IP address of the local gateway.
- **Metric**
Enter the metric value of current static route rule. The smaller value, the higher priority.
- **Interface**
Please refer to the Network->Route->Status interface.

4.5.3 VRRP

The Virtual Router Redundancy Protocol (VRRP) is a computer networking protocol that provides automatic assignment of available Internet Protocol (IP) routers for participating hosts. The VRRP router who has the highest number will become the virtual master router. The VRRP router number ranges from 1 to 255 and usually we use 255 for the highest priority and 100 for backup. If the current virtual master router receives an announcement from a group member (Router ID) with a higher priority, then the latter will pre-empt and become the virtual master router.

VRRP	
VRRP Network Settings	
Index	1
Enable	<input checked="" type="checkbox"/>
Interface	LAN0
Virtual Router ID	1
Authentication Type	None
Priority	100
Interval	1
Virtual IP Address	
<input type="button" value="Save"/> <input type="button" value="Close"/>	

Network->VRRP

- **Enable**
Check this box will enable VRRP.
- **Interface**
Select the interface of Virtual Router.
- **Virtual Router ID**
User-defined Virtual Router ID. Range: 1-255.
- **Authentication Type**
Select the authentication type for VRRP.
- **Priority**
Enter the VRRP priority range is 1-254 (a bigger number indicates a higher priority).
- **Interval**
Heartbeat package transmission time interval between routers in the virtual IP group. Range: 1-255.
- **Virtual IP Address**
Enter the virtual IP address of virtual gateway.

4.5.4 IP Passthrough

IP Passthrough mode, disables NAT and routing and passes the WAN IP address from the WAN interface to the device connected on the local Interface. It is used instead of Network Address Translation (NAT) in order to make the router "transparent" in the communication process.

IP Passthrough

General Settings

Enable	<input type="checkbox"/>
Passthrough Host MAC	<input type="text"/> ⓘ
Remote HTTPS Access Reserved	<input checked="" type="checkbox"/>
Remote Telnet Access Reserved	<input type="checkbox"/>
Remote SSH Access Reserved	<input type="checkbox"/>

Network->IP Passthrough

- **Enable**
Check this box will enable IP Passthrough.
- **Passthrough Host MAC**
Enter the MAC of passthrough host to receive the WAN IP address.
- **Remote HTTPS Access Reserved**
Check this box to allow to remote access the router via https while enable IP Passthrough mode.
- **Remote Telnet Access Reserved**
Check this box to allow to remote telnet to the router while enable IP Passthrough mode.
- **Remote SSH Access Reserved**
Check this box to allow to remote SSH to the router while enable IP Passthrough mode.

4.6 Applications

4.6.1 DDNS

DDNS is a system that allows the domain name data of a computer with a varying (dynamic) IP addresses held in a name server to be updated in real time in order to make it possible to establish connections to that machine without the need to track the actual IP addresses at all times. A number of providers offer Dynamic DNS services (DDNS), free or for a charge.

You could review the status of DDNS as below.

The screenshot displays the DDNS configuration page. At the top, there are tabs for 'Status' and 'DDNS'. Below the 'Status' tab is a table titled 'DDNS Status' with columns for 'Index', 'Status', 'Hostname', and 'Public IP Address'. Below the 'DDNS' tab is the 'General Settings' section, which includes a 'Check IP Interval' field set to '300' and a 'Log Level' dropdown menu set to 'Error'. A 'DDNS Settings' modal window is open, showing a table with columns for 'Index', 'Enable', 'Provider', 'Hostname', and 'Username'. The modal contains the following settings: Index (1), Enable (checked), Provider (no-ip), Hostname (empty), Enable SSL (checked), Username (empty), and Password (empty). 'Save' and 'Close' buttons are at the bottom of the modal.

DDNS

- **Status**
Display the DDNS status.
- **Hostname**
Display the hostname of DDNS.
- **Public IP Address**
Display the public IP address.
- **Check IP Interval**
Enter the interval, the modem will update the Dynamic DNS server of its carrier assigned IP address.
- **Log Level**
Select the log output level from "none", "Error", "Notice", "Info" and "Debug".

- **Enable**
Check this box to enable the DDNS service.
- **Provider**
Select the DDNS provider from the list, options from "DynDNS", "no-ip", "3322" and custom.
- **DDNS Server**
The internet address to communicate the Dynamic DNS information to. This option is available after you select **custom** on DDNS Provider.
- **DDNS Path**
DDNS path for custom type.
- **Check IP Server**
Check IP Server for custom type
- **Check IP Path**
Check IP Path for custom type.
- **Enable SSL**
Enable SSL for connection.
- **Username**
Enter the username used when setting up the account. Used to login to the Dynamic DNS service.
- **Password**
Enter the password associated with the account.
- **Hostname**
Enter the hostname associated with the account.

4.6.2 SMS

SMS allows user to send the SMS to control the router or get the running status of the router.

SMS
Gateway
Notification

General Settings

Enable

Enable SMS Control

Authentication Type Password

Allow Phone Book

Index	Description	Phone Number
+		

Phone Number Settings

Allow Phone Book

Index

Description

Phone Number

Save
Close

Application->SMS

- **Enable**
Check this box to enable SMS feature.
- **Enable SMS Control**
Check this box to enable SMS control feature.
- **Authentication Type**
Specify the authentication mode for SMS, optional for "None" and "Password".
- **Description**
Enter the description of the Phone Book
- **Phone Number**
Enter the special phone number and only allow this phone number to send SMS to the router

SMS Gateway allow to send SMS messages by using a valid syntax from serial device or ethernet device.

SMS	Gateway	Notification
General Settings		
Enable	<input checked="" type="checkbox"/>	
Authentication Type	Password	
SMS Source	Serial Port	
Serial Port Settings		
Serial Port	COM2	
Baud Rate	115200	
Data Bits	8	
Stop Bits	1	
Parity	None	
Application->SMS>Gateway		

- **Enable**
Check the box will enable SMS gateway.
- **Authentication Type**
Specify the authentication mode for SMS, optional for "None" and "Password".
- **SMS Source**
Specify SMS source to receive valid syntax, optional for "Serial Port" and "HTTP(S) GET/POST".
- **SMS Message Format**
Specify the SMS format between "Text" and "PDU" when reading SMS or reading SMS list via "HTTP(S) GET/POST"
- **Serial Port**
Select the serial port from COM1 or COM2.
- **Baud Rate**
Select the serial port baud rate. Supported values are 300, 600, 1200, 2400, 4800, 9600, 19200, 38400, 57600, or 115200.
- **Data Bits**
Select the values from 7 or 8.
- **Stop Bits**
Select the values from 1 or 2.
- **Parity**
Select values from none, even, odd, mark, space.

SMS Notification feature allow to send SMS notification to the pre-setting phone number when some of router status changed.

Notification Settings

Notification Settings

Index	<input style="width: 100%;" type="text" value="1"/>
Enable	<input checked="" type="checkbox"/>
Description	<input style="width: 100%;" type="text"/>
Phone Number	<input style="width: 100%;" type="text"/>
Enable Timestamp	<input checked="" type="checkbox"/>

Status Notify Settings

Startup	<input type="checkbox"/>
Reboot	<input type="checkbox"/>
NTP Update	<input type="checkbox"/>
LAN Port	<input type="checkbox"/>
WAN Port	<input type="checkbox"/>
WWAN Port	<input type="checkbox"/>
Active Link	<input type="checkbox"/>
IPSec Connection	<input type="checkbox"/>
Openvpn Connection	<input type="checkbox"/>

Save
Close

Application->SMS>Notification

- **Index**
Display the index of the notification channel, maximum is 10.
- **Description**
Add the description for notification channel.
- **Phone Number**
Pre-setting phone number to receive the notification
- **Timestamp**
Check this box to enable timestamp on the SMS notify.
- **Startup**
Send SMS notification to the pre-setting phone number when system startup.
- **Reboot**
Send SMS notification to the pre-setting phone number when system reboot.
- **NTP Update**
Send SMS notification to the pre-setting phone number when NTP update successfully.

- **LAN Port Status**
Send SMS notification to the pre-setting phone number when LAN port status changed.
- **WAN Port Status**
Send SMS notification to the pre-setting phone number when WAN port status changed.
- **WWAN Port**
Send SMS notification to the pre-setting phone number when WWAN port status changed.
- **Active Link**
Send SMS notification to the pre-setting phone number when active link status changed.
- **IPSec Connection**
Send SMS notification to the pre-setting phone number when IPSec connection status changed.
- **OpenVPN Connection**
Send SMS notification to the pre-setting phone number when OpenVPN Connection Status changed.
- **Modbus Alarm**
Send SMS notification to pre-setting phone number when trigger modbus alarm.

4.6.3 Schedule Reboot

Schedule reboot allows user to define the time for router reboot itself.

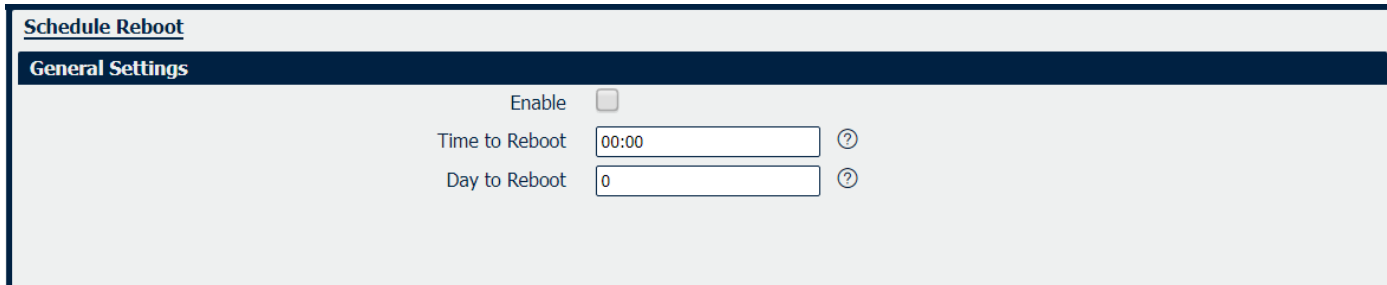

Application->Schedule Reboot

- **Enable**
Check this box to enable schedule reboot feature.
- **Time to Reboot**
Enter the time of each day to reboot device. Format: HH(00-23):MM(00-59).
- **Day to Reboot**
Enter the day of each month to reboot device. 0 means every day.

4.6.4 Call

Call reboots allow the user to make a call to the router to control it restart.

Call

General Settings

Enable Call Control

Call Reboot

Allow Phone Book

Index	Description	Phone Number
-------	-------------	--------------

Phone Number Settings

Allow Phone Book

Index

Description

Phone Number

Save **Close**

Application->Call

- **Enable Call Control**
Check this box to enable call control feature.
- **Call Reboot**
Check this box to enable call reboot feature.
- **Description**
Define the description of the phone book
- **Phone Number**
Specify the phone number that allow to make a call to the router.

4.7 VPN

4.7.1 OpenVPN

OpenVPN is an open-source virtual private network (VPN) product that offers a simplified security framework, modular network design, and cross-platform portability.

You could review all OpenVPN connection as below.

Status		OpenVPN	X.509 Certificate	Configuration Files		
OpenVPN Information						
Index	Enable	Description	Mode	Status	Uptime	Local Virtual IP
OpenVPN Server Status						
Index	Common Name	Status	Uptime	Remote Virtual IP	Remote IP	Remote Port

VPN->OpenVPN->Status>OpenVPN Information

- **Enable**
Displays current OpenVPN settings is enable or disable.
- **Mode**
Displays current working mode of OpenVPN.
- **Status**
Displays the current VPN connection status.
- **Uptime**
Displays the connection time since VPN is established.
- **Local Virtual IP**
Displays the virtual IP address obtain from remote side.

VPN->OpenVPN->Status>OpenVPN Server Status

- **Common Name**
Displays the common name of OpenVPN client.
- **Status**
Displays the current VPN connection status.
- **Uptime**
Displays the connection time since VPN is established.
- **Remote Virtual IP**
Displays the virtual IP address of OpenVPN client.
- **Remote IP**
Displays the remote IP address of OpenVPN client.
- **Remote Port**
Displays the remote port obtain of OpenVPN client.

OpenVPN Settings

General Settings

Index	<input type="text" value="1"/>
Enable	<input checked="" type="checkbox"/>
Description	<input type="text"/>
Mode	<input type="text" value="Client"/>
Protocol	<input type="text" value="UDP"/>
Connection Type	<input type="text" value="TUN"/>
Server Address	<input type="text"/>
Server Port	<input type="text" value="1194"/>
Authentication Method	<input type="text" value="X.509"/> ?
Encryption Type	<input type="text" value="BF-CBC"/>
Renegotiate Interval	<input type="text" value="3600"/>
Keepalive Interval	<input type="text" value="20"/>
Keepalive Timeout	<input type="text" value="60"/>
Fragment	<input type="text" value="0"/> ?
Private Key Password	<input type="text"/>
Output Verbosity Level	<input type="text" value="3"/>

Advanced Settings

Enable NAT

VPN->OpenVPN

- **Enable**
Check this box to enable OpenVPN tunnel.
- **Description**
Enter a description for this OpenVPN tunnel.
- **Mode**
Select from "P2P", "Client" or "Server".
- **Protocol**
Select from "UDP", "TCP Client" or "TCP Server"
- **Connection Type**
Select from "TUN", "TAP" which are two different kinds of device interface for OpenVPN. The difference between TUN and TAP device is that a TUN device is a point-to-point virtual device on network while a TAP device is a virtual device on Ethernet.
- **Server Address**
Enter the IP address or domain of remote server.
- **Server Port**
Enter the negotiate port on OpenVPN server.

- **Max Client**
Allow max OpenVPN client connect to OpenVPN server.
- **Authentication Method**
Select from "X.509", "Pre-shared", "Password", and "X.509 And Password".
- **Encryption Type**
Select from "BF-CBC", "DES-CBC", "DES-EDE-CBC", "DES-EDE3-CBC", "AES-128-CBC", "AES-192-CBC" and "AES-256-CBC".
- **Username**
Enter the username for authentication when selection from "Password" or "X.509 And Password".
- **Password**
Enter the password for authentication when selection from "Password" or "X.509 And Password".
- **Local IP Address**
Enter the local virtual IP address when select "P2P" and "OpenVPN Server" mode.
- **Remote IP Address**
Enter the remote virtual IP address when select "P2P" mode.
- **Local Port**
Specify the OpenVPN Server port, default is 1194.
- **Topology**
Select the possible topology from "Subnet" and "Net30"
Subnet: The recommended topology for modern servers. Note that this is not the current default. Addressing is done by IP & netmask.
Net30: This is the old topology for support with Windows clients running 2.0.9 or older clients. This is the default as of OpenVPN 2.3, but not recommended for current use. Each client is allocated a virtual /30, taking 4 IPs per client, plus 4 for the server.
- **Subnet**
Specify the subnet for the OpenVPN client. Default is 10.8.0.0
- **Subnet Netmask**
Specify the subnet netmaks for OpenVPN client. Default is 255.255.255.0
- **TAP Bridge**
Select the specified LAN that bridge with OpenVPN tunnel when select "TAP" connection type.
- **Renegotiate Interval**
Enter the renegotiate interval if connection is failed.
- **Keepalive Interval**
Enter the keepalive interval to check the tunnel is active or not.
- **Keepalive Timeout**
Enter the keepalive timeout, once connection is failed it will trigger the OpenVPN reconnect.
- **Fragment**
Enter the fragment size, 0 means disable.
- **Private Key Password**
Enter the private key password for authentication when selection from "X.509" or "X.509 And Password".
- **Output Verbosity Level**
Enter the level of the output log and values.

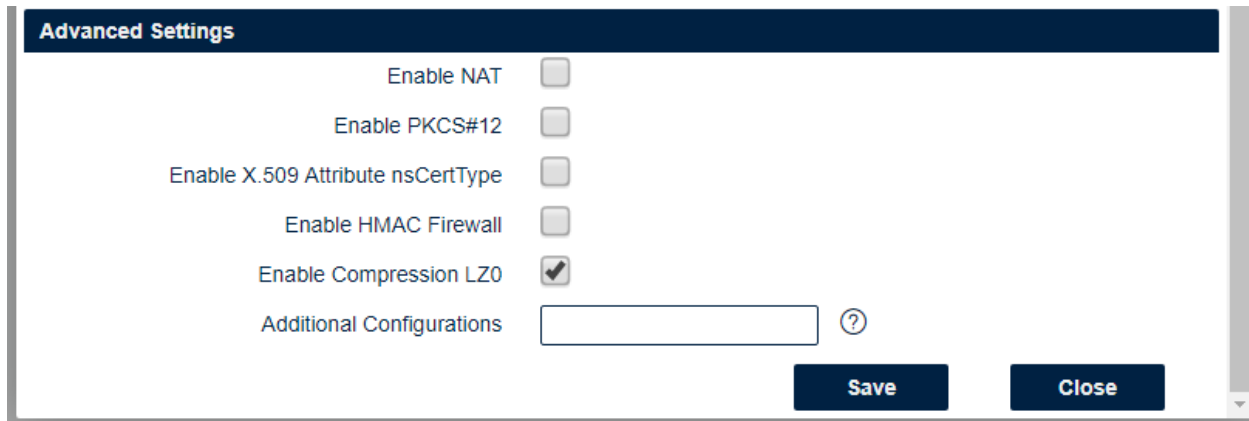

VPN->OpenVPN->Advanced Settings

- **Enable NAT**
Check this box to enable NAT, the source IP of host behind router will be disguised before accessing the remote end.
- **Enable Default Gateway**
Check this box to enable default gateway, all the data traffic will go through the VPN tunnel.
- **Enable PKCS#12**
It is an exchange of digital certificate encryption standard, used to describe personal identity information.
- **Enable CRL**
Check this box to enable CRL(Certificate Revocation List).
- **Enable Client to Client**
Check this box to allow client to communicate with each other.
- **Enable Duplicate CN**
Check this box allow multiple clients connect to the server with the same certificate/key files or common names.
- **Enable IP Persist**
Check this box to keep the IP address unchanged.
- **Enable X.509 Attribute nsCertType**
Require that peer certificate was signed with an explicit nsCertType designation of "server".
- **Enable HMAC Firewall**
Add additional layer of HMAC authentication on the top of the TLS control channel to protect against DoS attacks.
- **Enable Compression LZ0**
Compress the data.
- **Additional Configurations**
Enter some other options of OpenVPN in this field. Each expression can be separated by a ','.

Status	OpenVPN	<u>X.509 Certificate</u>	Configuration Files
X.509 Certificate Import			
OpenVPN Mode	Client ▾		
Connection Index	1 ▾		
CA Certificate	Choose File	No file chosen	
Local Certificate File	Choose File	No file chosen	
Local Private Key	Choose File	No file chosen	
HMAC Firewall Key	Choose File	No file chosen	
Pre-shared Key	Choose File	No file chosen	
PKCS#12 Certificate	Choose File	No file chosen	
User-Password File	Choose File	No file chosen	
Private Key Password File	Choose File	No file chosen	
X.509 Certificate Files			
Index	File Name	File Size	Date Modified

VPN->OpenVPN->X.509 Certificate

- **OpenVPN Mode**
Select OpenVPN working mode between Server and Client.
- **Connection Index**
Displays the current connection index for OpenVPN channel.
- **CA Certificate**
Import CA certificate file.
- **Local Certificate File**
Import Local Certificate file.
- **Local Private Key**
Import Local Private Key file.
- **DH File**
Import DH file when works as OpenVPN server.
- **HMAC Firewall Key**
Import HMAC Firewall Key file.
- **Pre-shared Key**
Import the pre-shared key file.
- **PKCS#12 Certificate**
Import PKCS#12 Certificate.
- **User-Password File**
Import the username and password file when import the OpenVPN client file.
- **Private Key Password File**
Import the private key password file when import the OpenVPN client file.
- **CRL File**
Import CRL file.

Status **OpenVPN** **X.509 Certificate** **Configuration Files**

Configuration Files Settings

Connection Index

Configuration Files 

Configuration Files Download

Configuration Files List

Index	File Name	File Size	Date Modified
-------	-----------	-----------	---------------

VPN->OpenVPN->Configuration Files

- **Connection Index**
Select OpenVPN connection index.
- **Configuration Files**
Import the OpenVPN client file.
- **Configuration Files Download**
Download the OpenVPN client configuration.
- **Configuration Files List**
Display the imported OpenVPN client file.

4.7.2 IPSec

IPSec facilitates configuration of secured communication tunnels. The various tunnel configurations will be displayed in the Tunnel Table at the bottom of the page. All tunnels are create using the ESP (Encapsulating Security Payload) protocol.

Status		IPSec		
IPSec Information				
Index	Enable	Description	Status	Uptime

VPN->IPSec->Status

- Enable**
 Displays current IPSec settings is enable or disable.
- Description**
 Displays the description of current VPN channel.
- Status**
 Displays the current VPN connection status.
- Uptime**
 Displays the connection time since VPN is established.

IPSec Settings

General Settings

Index	<input type="text" value="1"/>
Enable	<input checked="" type="checkbox"/>
Description	<input type="text"/>
Remote Gateway	<input type="text"/>
IKE Version	<input type="text" value="IKEv1"/>
Connection Type	<input type="text" value="Tunnel"/>
Negotiation Mode	<input type="text" value="Main"/>
Authentication Method	<input type="text" value="Pre-shared Key and Xauth"/>
Local Subnet	<input type="text"/>
Local Pre-shared Key	<input type="text"/>
Local ID Type	<input type="text" value="IPv4 Address"/>
Xauth Identity	<input type="text"/>
Xauth Password	<input type="text"/>
Remote Subnet	<input type="text"/>
Remote ID Type	<input type="text" value="IPv4 Address"/>

VPN->IPSec

- **Enable**
Select Enable will launch the IPSec process.
- **Description**
Enter a description for this IPSec VPN tunnel.
- **Remote Gateway**
Enter the IP address of the remote endpoint of the tunnel.
- **IKE Version**
Internet Key Exchange, select from "IKEv1" or "IKEv2".
- **Connection Type**
Select from "Tunnel" or "Transport".
Tunnel: In tunnel mode, the entire IP packet is encrypted and authenticated. It is then encapsulated into a new IP packet with a new IP header. Tunnel mode is used to create virtual private networks for network-to-network communications.
Transport: In transport mode, only the payload of the IP packet is usually encrypted or authenticated. The routing is intact, since the IP header is neither modified nor encrypted.
- **Negotiation Mode**
Select from "Main" or "Aggressive".
- **Authentication Method**
Select from "Pre-shared Key" or "Pre-shared Key and Xauth".
- **Local Subnet**
Enter the IP address with mask if a network beyond the local LAN will be sending packets through the tunnel. Multiple subnets separated by commas.
NOTE: The Remote subnet and Local subnet addresses must not overlap!
- **Local Pre-shared Key**
Enter the pre-shared key which match the remote endpoint.
- **Local ID Type**
The local endpoint's identification. The identifier can be a host name or an IP address.
- **Xauth Identity**
Enter Xauth identity after "Pre-shared Key and Xauth" on authentication Method is enabled.
- **Xauth Password**
Enter Xauth password "Pre-shared Key and Xauth" on authentication Method is enabled.
- **Remote Subnet**
Enter an IP address with mask if encrypted packets are also destined for the specified network that is beyond the Remote IP Address. Multiple subnets separated by commas.
NOTE: The Remote subnet and Local subnet addresses must not overlap!
- **Remote ID Type**
The authentication address of the remote endpoint.

IKE Proposal Settings		
Encryption algorithm	AES-256	
Hash Algorithm	SHA2 256	
Diffie-Hellman group	Group5(modp1536)	
Lifetime	1440	
ESP Proposal Settings		
Encryption algorithm	AES-256	
Hash Algorithm	SHA2 256	
Diffie-Hellman group	Group5(modp1536)	
Lifetime	60	
Advanced Settings		
DPD Interval	30	?
DPD Timeout	90	?
Additional Configurations		?
<input type="button" value="Save"/> <input type="button" value="Close"/>		

VPN->IPSec

- Encryption Algorithm (IKE)**
 Select 3DES AES-128, AES-192, or AES-256 encryption.
- Hash Algorithm (IKE)**
 Select from MD5, SHA1, SHA2 256, SHA2 384 or SHA2 512 hashing.
- Diffie-Hellman Group (IKE)**
 Negotiate (None) or use 768 (Group 1), 1024 (Group 2), 1536 (Group 5) or 2048 (Group 14) etc.
- Lifetime (IKE)**
 How long the keying channel of a connection should last before being renegotiated.
- Encryption Algorithm (ESP)**
 Select 3DES AES-128, AES-192, or AES-256 encryption.
- Hash Algorithm (ESP)**
 Select from MD5, SHA1, SHA2 256, SHA2 384 or SHA2 512 hashing.
- Diffie-Hellman Group (ESP)**
 Negotiate (None) or use 768 (Group 1), 1024 (Group 2), 1536 (Group 5) or 2048 (Group 14) etc.
- Lifetime (ESP)**
 How long a particular instance of a connection should last, from successful negotiation to expiry.
- DPD Interval**
 Enter the interval after which DPD is triggered if no IPsec protected packets is received from the peer.
- DPD Timeout**
 Enter the remote peer probe response timer.
- Additional Configurations**
 Enter some other options of IPsec in this field. Each expression can be separated by a ';'.

4.7.3 GRE

Generic Routing Encapsulation (GRE) is a protocol that encapsulates packets in order to route other protocols over IP networks. It's a tunneling technology that provides a channel through which encapsulated data message could be transmitted and encapsulation and decapsulation could be realized at both ends.

Status		GRE		
GRE Information				
Index	Enable	Description	Mode	Status

VPN->GRE->Status

- **Enable**
Displays current GRE settings is enable or disable.
- **Description**
Displays the description of current VPN channel.
- **Mode**
Displays the current VPN mode.
- **Status**
Displays the current VPN connection status.

GRE Settings

General Settings

Index	<input type="text" value="1"/>
Enable	<input checked="" type="checkbox"/>
Description	<input type="text"/>
Mode	<input type="text" value="Layer 3"/>
Remote Gateway	<input type="text"/>
Local Virtual IP	<input type="text"/>
Local Virtual Netmask	<input type="text" value="255.255.255.252"/>
Tunnel key	<input type="text"/> ?
Enable NAT	<input type="checkbox"/>
Enable Default Route	<input type="checkbox"/>

Advanced Settings

Binding Interface	<input type="text"/> ?
-------------------	---

VPN->GRE

- **Enable**
Check this box to enable GRE.
- **Description**
Enter the description of current VPN channel.
- **Mode**
Specify the running mode of GRE, optional are "Layer 2" and "Layer 3".
- **Remote Gateway**
Enter the remote IP address of peer GRE tunnel.
- **Local Virtual IP**
Enter the local tunnel IP address of GRE tunnel.
- **Local Virtual Netmask**
Enter the local virtual netmask of GRE tunnel.
- **Tunnel Key**
Enter the authentication key of GRE tunnel.
- **Enable NAT**
Check this box to enable NAT function.
- **Bridge Interface**
Specify the bridge interface work with Layer 2 mode.
- **Enable Default Route**
Check this box to make all the traffic go through VPN tunnel.
- **Binding Interface**
Only specified interface turn into active WAN will start the VPN tunnel.

4.8 Maintenance

4.8.1 Upgrade

When newer versions of NW20 firmware become available, the user can manually update the unit by uploading a package to the unit.

NOTE: The unit need manually reboots once the upload completes, thus taking the NW20 router out of service during approximately 1 minute. Unless otherwise stated, the user is not expected to take any special precautions.

CAUTION: It is important to have a stable power source and ensure that power to the Fusion is not interrupted during a firmware upgrade.

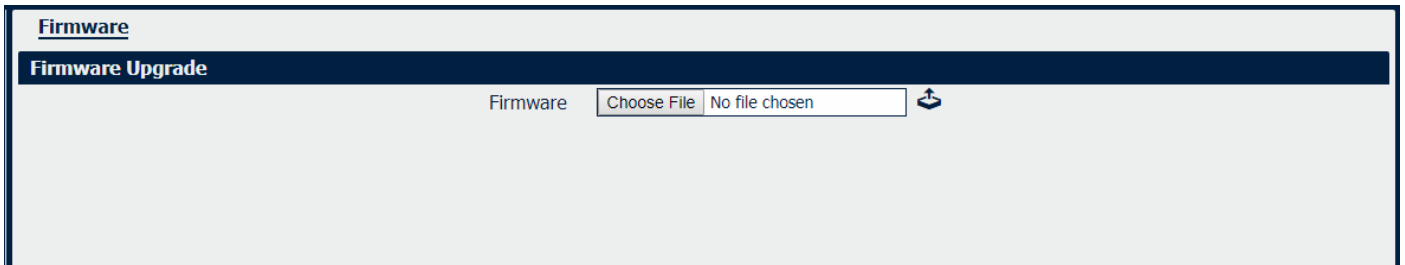

4.8.2 Software

When release a new feature (APP Package) of NW20 router, the user can manually install to the unit by uploading a package. Or user can uninstall this feature (APP Package) from router.

NOTE: The unit need manually reboots once the upload/uninstall completes, thus taking the NW20 router out of service during approximately 1 minute. Unless otherwise stated, the user is not expected to take any special precautions.

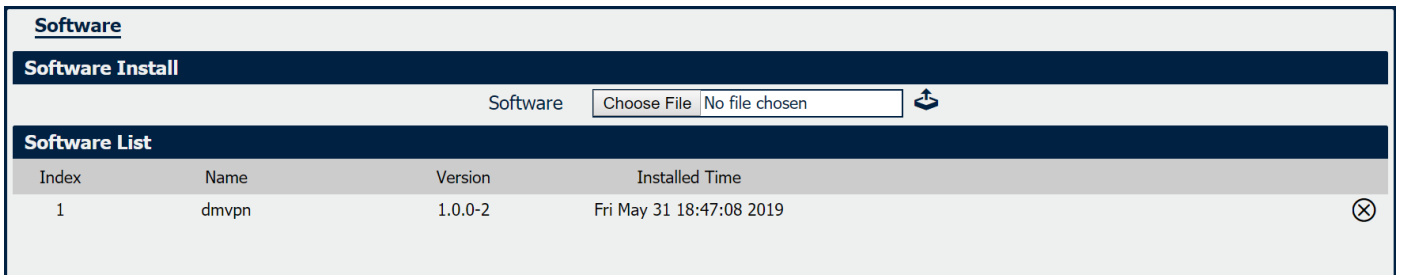

Click  to upload the APP Package.

Click  to delete the APP Package.

Note: We are working different kinds of the APP Packages. Please contact us to get them in case of you would like to test.

4.8.3 System

This section allows you to review the device system settings.

<u>General</u>	Accounts	Syslog	Web Server	Telnet	SSH	Security
General Settings						
Hostname	<input type="text" value="router"/>					
User LED Type	<input type="text" value="None"/>					
Time Zone Settings						
Time Zone	<input type="text" value="UTC+01:00"/>					
Customized Time Zone	<input type="text"/> ?					
Time Synchronisation						
Enable	<input checked="" type="checkbox"/>					
Primary NTP Server	<input type="text" value="pool.ntp.org"/>					
Secondary NTP Server	<input type="text" value="1.pool.ntp.org"/>					
Synchronize Modem Time	<input type="checkbox"/>					
Enable NTP Server	<input type="checkbox"/>					

System->General

- **Hostname**
User-defined router name, which might be use for IPSec local ID identify.
- **User LED Type**
Defined the User LED behavior.
- **Time Zone**
Select the zone where the device is in use.
- **Customized Time Zone**
Customized the zone where the device is in use.
- **Enable (NTP Client)**
Selected Enabled to utilize the NTP client to synchronize the device clock over the network using a time server (NTP server).
- **Primary NTP Server**
Enter the IP address (or host name) of the primary time server.
- **Secondary NTP Server**
Enter the IP address (or host name) of the secondary time server.
- **Synchronize Modem Time**
Synchronize the time from cellular module.
- **Enable NTP Server**
Check the box to make the router as a NTP server.

General	Accounts	Syslog	Web Server	Telnet	SSH	Security
Account Settings						
	Administrator	<input type="text" value="admin"/>				
	Old Password	<input type="text"/>				
	New Password	<input type="text"/>				
	Confirm Password	<input type="text"/>				
Visitor Settings						
Index	Username	Password				

System->Account

- **Administrator**
Displays the name of current administrator, default as "admin".
- **Old Password**
Enter the old password of administrator.
- **New Password**
Enter the new password of administrator.
- **Confirm Password**
Confirm the new password of administrator.

Account Settings	
Account Settings	
Index	<input type="text" value="1"/>
Username	<input type="text"/>
Password	<input type="text"/>
	<input type="button" value="Save"/>
	<input type="button" value="Close"/>

System->Account

- **Username**
Enter a username of visitor privilege
- **Password**
Enter the new password of current visitor account.

Syslog displays system logs that are stored in the log buffers.

General	Accounts	<u>Syslog</u>	Web Server	Telnet	SSH	Security
General Settings						
		Log Location	RAM			
		Log Level	Debug			
Remote Syslog Settings						
		Enable Remote Syslog	<input type="checkbox"/>			
		Remote Syslog Server				
		Remote Syslog Port	514			

System->Syslog

- **Log Location**
Select the log store location from "RAM" or "Flash".
- **Log Level**
Select the log output level from "Debug", "Notice", "Info", "Warning" or "Error".
- **Enable Remote Syslog**
Check this box to enable remote syslog connection.
- **Remote Syslog Server**
Enter the IP address of remote syslog server.
- **Remote Syslog Port**
Enter the port for remote syslog server listening.

General	Accounts	Syslog	<u>Web Server</u>	Telnet	SSH	Security
General Settings						
			HTTP Port	80		
			HTTPS Port	443		
Certificate Settings						
			Private Key	Choose File	No file chosen	
			Certificate File	Choose File	No file chosen	

System->Web Server

- **HTTP Port**
Enter the port for Hypertext Transfer Protocol. A well-known port for HTTP is port 80.
- **HTTPS Port**
Enter the port for HTTPS Protocol. A well-known port for HTTPS is port 443.
- **Private Key**
Import private Key file for HTTPS connection.
- **Certificate File**
Import certificate file for HTTPS connection.

General	Accounts	Syslog	Web Server	<u>Telnet</u>	SSH	Security
General Settings						
Telnet Port				<input type="text" value="23"/>		

System->Telnet

- **Telnet Port**
Enter the port for telnet access. A well-known port for HTTP is port 23.

General	Accounts	Syslog	Web Server	Telnet	<u>SSH</u>	Security
General Settings						
SSH Port				<input type="text" value="22"/>		
Allow Password Authentication				<input checked="" type="checkbox"/>		
Public Key				<input type="text"/>		

System->SSH

- **SSH Port**
Enter the port for SSH access. A well-known port for HTTP is port 22.
- **Allow Password Authentication**
Check this box to enable SSH authentication.
- **Public Key**
Enter the public Key SSH authentication.

General	Accounts	Syslog	Web Server	Telnet	SSH	<u>Security</u>
Access Settings						
Remote HTTP Access				<input type="checkbox"/>		
Remote HTTPS Access				<input checked="" type="checkbox"/>		
Remote Telnet Access				<input type="checkbox"/>		
Remote SSH Access				<input checked="" type="checkbox"/>		
Local HTTP Access				<input checked="" type="checkbox"/>		
Local HTTPS Access				<input checked="" type="checkbox"/>		
Local Telnet Access				<input checked="" type="checkbox"/>		
Local SSH Access				<input checked="" type="checkbox"/>		
Ping Settings						
Remote Ping Request				<input checked="" type="checkbox"/>		
Local Ping Request				<input checked="" type="checkbox"/>		
DDoS Defense				<input checked="" type="checkbox"/>		

System->Security

- **Remote HTTP Access**
Check this box to allow remote HTTP access.

- **Remote HTTPS Access**
Check this box to allow remote HTTPS access.
- **Remote Telnet Access**
Check this box to allow remote Telnet access.
- **Remote SSH Access**
Check this box to allow remote SSH access.
- **Local HTTP Access**
Check this box to allow local HTTP access.
- **Local HTTPS Access**
Check this box to allow local HTTPS access.
- **Local Telnet Access**
Check this box to allow local Telnet access.
- **Local SSH Access**
Check this box to allow local SSH access.
- **Remote Ping Request**
Check this box to allow remote ping request.
- **Local Ping Request**
Check this box to allow local ping request.
- **DDoS Defense**
Check this box to enable DDoS defense.

4.8.4 Configuration

The Unit Configuration tab allows you to save parameters (settings in the Web interface) to a file. Conversely, if you have saved settings from the NW20 router to a file, you can Import these previously-saved configuration settings to the NW20 router as well.

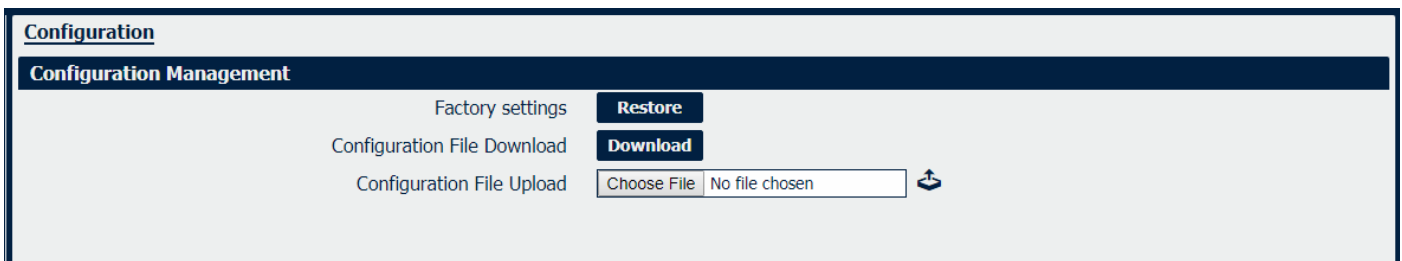

System->Configuration

- **Restore**
Reset the unit to factory default settings.
- **Download**
Download the configuration file from NW20 router.
- **Configuration File Upload**
Import previously saved configuration file.

4.8.5 Debug Tools

<u>Ping</u>	Traceroute	AT Debug	Sniffer
Ping Settings			
		Host Address	<input type="text"/>
		Ping Count	<input type="text" value="5"/>
		Local IP Address	<input type="text"/>

Debug Tools->Ping

- **Host Address**
Enter a host IP address or domain name for ping.
- **Ping Count**
Enter the ping times.
- **Local IP Address**
Enter the ping source IP address or leave it blank.

Ping	<u>Traceroute</u>	AT Debug	Sniffer
Traceroute Settings			
		Host Address	<input type="text"/>
		Max Hops	<input type="text" value="30"/>

Debug Tools->Traceroute

- **Host Address**
Enter a host IP address or domain name for traceroute.
- **Max Hops**
Enter the max hops for traceroute.

Ping	Traceroute	<u>AT Debug</u>	Sniffer
AT Debug Settings			
		AT Command	<input type="text"/>

Debug Tools->AT Debug

- **AT Command**
Enter the AT command of the module.

Ping	Traceroute	AT Debug	Sniffer
Sniffer Settings			
	Source Host	<input type="text"/>	
	Source Port	<input type="text"/>	
	Destination Host	<input type="text"/>	
	Destination Port	<input type="text"/>	
	Interface	<input type="text"/>	
Sniffer Files List			
Index	File Name	File Size	Date Modified

Debug Tools->Sniffer

- **Source Host**
Enter the source host IP address.
- **Source Port**
Enter the source port.
- **Destination Host**
Enter the destination host IP address.
- **Destination Port**
Enter the destination port.
- **Interface**
Enter the interface that the data traffic goes through.
- **File Name**
Display the file name of the packages.
- **File Size**
Display the size of the package.
- **Date Modified**
Display the date of the package.

Appendix A -Glossary

APN:	Access Point Name
GPRS:	General Packet Radio Service
HSPA:	High Speed Packet Access
HSDPA:	High-Speed Downlink Packet Access
HSUPA:	High-Speed Uplink Packet Access
LTE:	3GPP Long Term Evolution
IMEI:	International Mobile Equipment Identity
ICCID:	Integrated Circuit Card Identifier
PIN:	Personal Identification Number
PPP:	Point-to-Point Protocol
RSSI:	Received Signal Strength Indication
SIM:	Subscriber Identity Module
SMS:	Short Message Service
DHCP:	Dynamic Host Configuration Protocol
LAN:	Local Area Network
LED:	Light-Emitting Diode
NTP:	Network Time Protocol
SMA:	SubMiniature version A (connector)
SSID:	Service Set Identifier
TCP/IP:	Transmission Control Protocol / Internet Protocol
UDP:	User Datagram Protocol
VPN:	Virtual Private Network
Wi-Fi or WiFi:	Wireless Fidelity
VDC:	Voltage, Direct Current

Appendix B - Q&A

No Signal

Phenomenon

NW20 Router modem status show no signal.

Possible Reason

- Antenna installation is wrong.
- Modem failure.

Solution

- Check the LTE antenna or replace with new one.
- Check the cellular page confirm modem is detected correctly or not.

Cannot detect SIM card

Phenomenon

NW20 Router cannot detect SIM card, cellular is not failed to connect to base station.

Possible Reason

- SIM card damage.
- SIM bad contact.

Solution

- Replace SIM card.
- Re-install SIM card.

Poor Signal

Phenomenon

NW20 Router no signal or poor signal.

Possible Reason

- Antenna installation is wrong.
- Area signal weak.

Solution

- Check the antenna and re-connect it.
- Contact Telecom Operator to confirm signal problem.
- Change to high-gain antenna.

IPSec VPN established, but LAN to LAN cannot communicate

Phenomenon

IPSec VPN established, but LAN to LAN cannot communicate

Possible Reason

- Both subnets are not match the interested traffic.
- IPSec second phase (ESP) settings is not match.

Solution

- Check the both subnet settings.
- Check IPSec second phase (ESP) setting.

Forget Router Password

Phenomenon

Forget router login password.

Possible Reason

User has changed the password.

Solution

After router power on, press RESET button between 3 to 10 seconds then release, router need manually reboot and reset to factory default settings (Username/Password is admin/admin).

Appendix C - CLI

Command-line interface (CLI) is a software interface that provide another configurable way to set parameters on our router. We could use Telnet or SSH connect to our router for CLI input.

NW20 CLI Access

sparrow.router login: **admin**

Password: **admin**

>

CLI reference commands

>?

config	Change to the configuration mode
exit	Exit this CLI session
help	Display an overview of the CLI syntax
ping	Ping
reboot	Reboot system
show	Show running configuration or running status
telnet	Telnet Client
tracert	TraceRoute
upgrade	Upgrade firmware
version	Show firmware version

e.g.

```
> version
1.0.0 (40ebe90)
```

```
> show wifi
wifi
{
  "status":"Ready",
  "mac":"a8:3f:a1:e0:ab:81",
  "ssid":"NW20-WAN",
  "channel":"6",
  "width":"40 MHz",
  "txpower":"20.00 dBm"
}
```

```
> ping www.baidu.com
PING www.baidu.com (14.215.177.38): 56 data bytes
64 bytes from 14.215.177.38: seq=0 ttl=54 time=10.826 ms
```

64 bytes from 14.215.177.38: seq=1 ttl=54 time=10.284 ms
64 bytes from 14.215.177.38: seq=2 ttl=54 time=10.073 ms
64 bytes from 14.215.177.38: seq=3 ttl=54 time=10.031 ms
64 bytes from 14.215.177.38: seq=4 ttl=54 time=10.347 ms

--- www.baidu.com ping statistics ---
5 packets transmitted, 5 packets received, 0% packet loss
round-trip min/avg/max = 10.031/10.312/10.826 ms
>

How to Configure the CLI

CONTEXT SENSITIVE HELP

[?] - Display context sensitive help. This is either a list of possible command completions with summaries, or the full syntax of the current command. A subsequent repeat of this key, when a command has been resolved, will display a detailed reference.

AUTO-COMPLETION

The following keys both perform auto-completion for the current command line. If the command prefix is not unique then the bell will ring and a subsequent repeat of the key will display possible completions.

[enter] - Auto-completes, syntax-checks then executes a command. If there is a syntax error then offending part of the command line will be highlighted and explained.

[space] - Auto-completes, or if the command is already resolved inserts a space.

MOVEMENT KEYS

[CTRL-A] - Move to the start of the line
[CTRL-E] - Move to the end of the line.
[up] - Move to the previous command line held in history.
[down] - Move to the next command line held in history.
[left] - Move the insertion point left one character.
[right] - Move the insertion point right one character.

DELETION KEYS

[CTRL-C] - Delete and abort the current line
[CTRL-D] - Delete the character to the right on the insertion point.
[CTRL-K] - Delete all the characters to the right of the insertion point.
[CTRL-U] - Delete the whole line.
[backspace] - Delete the character to the left of the insertion point.

ESCAPE SEQUENCES

!! - Substitute the the last command line.
!N - Substitute the Nth command line (absolute as per 'history' command)
!-N - Substitute the command line entered N lines before (relative)